

CONSTRUCTION SAFETY PHASING PLAN FOR EXTEND TAXIWAY A, REALIGN TAXIWAYS D/G/F BID PACKAGE 1

AT
ERIE INTERNATIONAL AIRPORT

ISSUED FOR BID
MAY 1, 2026

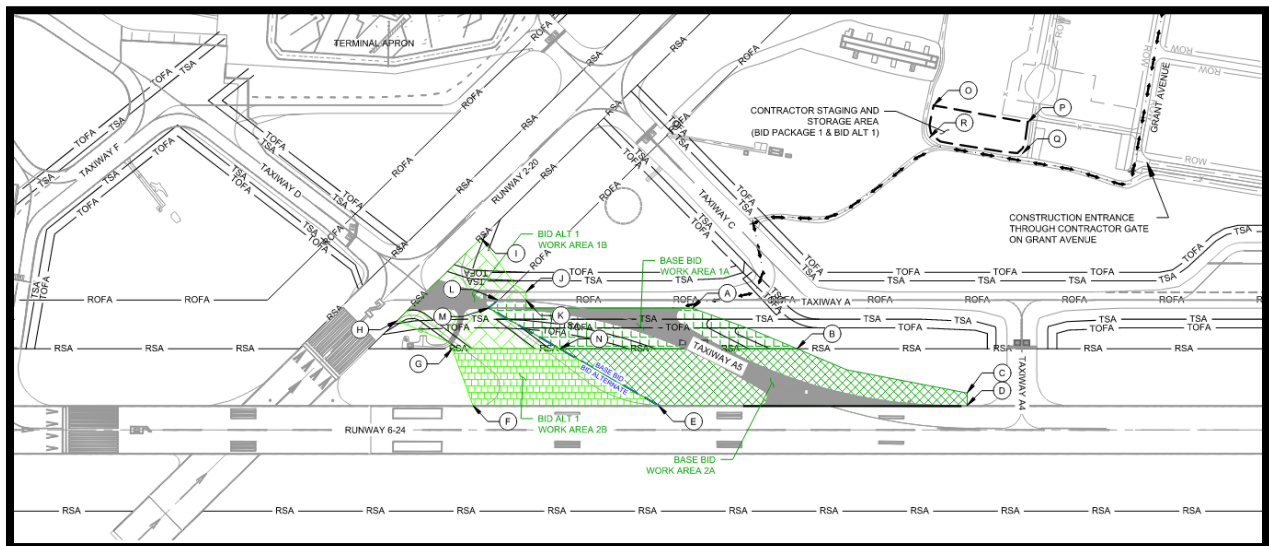

Table of Contents

A.	Purpose	4
B.	Scope	4
C.	Plan Requirements.....	5
205)	Coordination	5
a)	Design Meetings	5
b)	Pre-Bid Conference.....	5
c)	Pre-Construction Meeting	5
d)	Contractor Progress Meetings	5
e)	FAA Air Traffic Organization Coordination	5
f)	Other Coordination	6
206)	Project Phasing	6
207)	Areas and Operations Affected by the Construction Activity	6
208)	Protection of Navigation Aids (NAVAIDS) and Utilities	6
209)	Contractor Access.....	6
a)	Construction Site Access and Haul Roads	7
b)	Contractor Staging Area.....	7
c)	Contractor Employee and Equipment Parking.....	8
d)	Vehicle Condition	8
e)	Location of Stockpiled Materials	9
f)	Vehicle and Pedestrian Operations.....	9
g)	Required Escorts.....	9
h)	Badging and Training Requirements for Employees and Vehicle Drivers	10
i)	Maintenance of the Secured Area of the Airport.....	10
210)	Wildlife Management.....	10
211)	Foreign Object Debris (FOD) Management.....	10
212)	Hazardous Materials (HAZMAT) Management.....	11
213)	Notification of Construction Activities.....	11
214)	Inspection Requirements	13
215)	Underground Utilities.....	13
216)	Penalties.....	15
217)	Special Conditions	15
218)	Runway and Taxiway Visual Aids	15
219)	Marking and Signs for Access Routes	16
220)	Hazard Marking and Lighting	16
a)	Hazard marking	16
b)	Marking and Lighting.....	16
c)	Equipment	17
221)	Work Zone Lighting for Nighttime Construction	17
222)	Protection of Runway and Taxiway Safety Areas	17
a)	Runway Safety Area (RSA).....	17
b)	Taxiway/Taxilane Safety Area (TSA)	17
c)	Taxiway/Taxilane Object Free Area (TOFA).....	18
d)	Obstacle Free Zone (OFZ).....	18
e)	Runway Approach/Departure Surfaces	18
223)	Other Limitations on Construction.....	18
a)	Prohibitions.....	18

List of Appendices

Appendix "A" Construction Safety Phasing Plan Drawings

A. Purpose

The prime responsibility for safety, supervision and inspection of airfield construction projects lies with the airport owner/operator. Aviation safety is the prime consideration at airports, especially during construction. The Airport Operator's Construction Safety Phasing Plan (CSPP) and the Contractor's Safety Plan Compliance Document (SPCD) are the primary tools to document safety compliance when coordinating construction activities with airport operations. These documents identify aspects of the construction project that pose a potential safety hazard to airport operations and outline respective mitigation procedures for each hazard. Our primary goal is to provide the highest possible level of safety, security and efficiency to all the airport users, from the airlines and tenants to the construction Contractors and ultimately the traveling public.

A Construction Safety Phasing Plan (CSPP) has been developed specifically for the **Extend Taxiway A, Realign Taxiways D/G/F – Bid Package 1** project at Erie International Airport (ERI). The purpose of the CSPP is to identify all construction activities that will occur within the Airport Operations Area (AOA) of the airfield and define how each construction area will comply with the requirements of FAR Part 139 and all applicable FAA rules and regulations.

The CSPP is a standalone document written by the Airport Operator to correspond with the safety and security provisions included within the project drawings and specifications as well as FAA Advisory Circular 150/5370-2G, *Operational Safety on Airports During Construction*. The CSPP is to be used by all personnel involved in the project. The CSPP covers the actions and responsibilities of design, construction, inspection, and airport personnel.

Upon successful award of this project the Contractor will be required to submit a "Safety Plan Compliance Document" (SPCD). Within the content of the SPCD, the Contractor will include a statement that they have read and understand the CSPP and how they will comply with all the requirements and safety procedures detailed within it. Any information not discussed in the original CSPP or **ANY** changes to the constructability of the project **MUST** be outlined in the SPCD and submitted to the airport and FAA for review. The SPCD must be submitted to and approved by the airport prior to the Notice-to-Proceed (NTP) date for physical construction of the project.

In the event the Contractor's activities are found to be in non-compliance with the requirements of the CSPP or SPCD, the airport's representatives will direct the Contractor in writing to immediately stop all operations of that particular work until such time as all deficiencies are mitigated and/or corrected to the satisfaction of the airport.

The CSPP and SPCD will be always available on the jobsite. It is the responsibility of the Contractor to ensure all construction personnel are familiar with the safety procedures and regulations of the airport.

B. Scope

This project includes the first phase to realign Taxiway D between Taxiway C and Runway 2-20 by constructing Taxiway A5 and demolishing a portion of the existing Taxiway D located in this project area. This includes all sawcutting, pavement removal, base course, pavement, topsoil grading, seeding and mulching, pavement marking, taxiway edge lighting, and taxiway guidance sign modifications required for both demolition and construction associated with this project.

C. Plan Requirements

205) Coordination

a) Design Meetings

A design review meeting with Erie International Airport (ERI) staff, FAA and Engineer was held on November 12, 2025 to discuss the project design and impacts to the airfield. Additional focused meetings with ERI, FAA, and Airport tenants will be scheduled as appropriate.

b) Pre-Bid Conference

The construction manager representative along with the Erie International Airport (ERI) shall conduct a pre-bid conference to help clarify and explain construction methods, procedures, quality issues and safety requirements of the contract.

c) Pre-Construction Meeting

A preconstruction meeting will be convened and conducted by the Airport and construction administration team. This conference will be used to discuss operational safety, testing, quality control, quality acceptance, security, safety, labor requirements, environmental factors and other factors that will pertain to this construction project. The preconstruction conference will be conducted as soon as practicable after the contract has been awarded and held before the notice to proceed is given to the Contractor. Participants in the preconstruction conference are anticipated to include: ERI Staff, Design Team, Construction Administration Team, FAA Airport's District Office, FAA Airport Traffic Control, FAA Flight Standards, FAA Tech Ops, Contractor, all affected airport users, Quality Control and Assurance laboratory representatives and Subcontractors. The information covered in this meeting will include, but is not limited to:

- Scope of Project
- Responsibilities and Lines of Communication
- Anticipated Notice to Proceed
- Interface with Other Projects
- Airport Safety and Security
- Quality Control Program
- Role of Resident Project Representative
- Sequence of Work/Detailed Construction Schedule
- Forms and Procedures
- Labor and Civil Rights Requirements
- Environmental
- Weekly Progress and Pre-Construction Meetings

d) Contractor Progress Meetings

During the duration of the project, weekly Contractor progress meetings will be held and conducted by the Construction Administration team. The progress meetings will cover operational safety and security, airport operations, project schedule, coordination including restrictions to aircraft operations areas and security, issuing notice to airmen (NOTAMs), environmental, quality control/quality acceptance, administration and pay applications, submittals and changes. Participants in the weekly progress meetings shall include at minimum the following: Airport Staff, Engineer, Contractor, and Subcontractors.

e) FAA Air Traffic Organization Coordination

Communication with the FAA Airport Traffic Control Tower will be coordinated by the Airport and/or the construction administration team. The FAA Airport Traffic Control Tower personnel will be invited to attend the preconstruction conference at which time the overall construction schedule will be presented.

Movement area closures are anticipated with project. A meeting will be scheduled with the FAA Airport Traffic Control Tower prior to the start of each major construction phase which significantly impacts/modifies airfield closures throughout the duration of the construction project. Participants in these meetings shall

include: Airport Staff, Design Team, Construction Administration Team, FAA Airport's District Office, FAA Airport Traffic Control, Contractor, and Subcontractors.

f) Other Coordination

The Realign Taxiway D Phase 1 Project is anticipated to be performed in the spring/summer 2027 construction season. There may be other projects at the airport that will be constructed concurrently.

206) Project Phasing

The proposed construction is within the Air Operations Area (AOA) and is to be completed in four phases, two sub phases as depicted on the Construction Safety Phasing Plan Drawing in Appendix A of this CSPP. The Construction Safety Phasing Plan Drawing identifies the phase elements for each phase including:

- Contractor work areas and description of work being performed
- Affected AOA, ARFF access routes, NAVAIDs
- Work hours available
- Duration
- Lighting, marking, and signage changes
- Required hazard marking, lighting, and signage
- Lead times for required notifications

207) Areas and Operations Affected by the Construction Activity

As shown on Sheet G-081 Construction Safety Phasing Plan drawing (Appendix A), a portion of Taxiway A and D, between Taxiway C and Runway 2-20 are to be closed to accommodate project work.

The Contractor is to remain clear of runway safety areas (250') from runway centerline. Unless under escort from ERI Operations or if authorized by ERI for movement area access and in direct radio communication with the ATCT, the Contractor is to remain clear of all Taxiway and Taxilane Object Free Areas (TOFA's). Runway 6/24 will be closed for Work Area 2A and 2B.

208) Protection of Navigation Aids (NAVAIDS) and Utilities

There are various FAA and Erie International Airport (ERI) owned navigational aids and utilities located on the airport and near the project site. The known locations of these above and below ground facilities and underground cables are shown on the drawings, however these may not be complete or accurate. Contractor will take all precautions necessary to protect these facilities, including, but not limited to; coordination with ERI and FAA tech ops personnel to identify above ground equipment and below ground facilities and cabling, and barricading around equipment as necessary to maintain separation between Contractor's equipment and airport facilities. Any damage to nav aids or other facilities will be repaired or replaced at Contractor's expense to the satisfaction of the owner. A NOTAM will be issued to close runways affected by unanticipated power outages of nav aids and the Contractor shall immediately restore power.

209) Contractor Access

The proposed construction is within the Air Operations Area (AOA) of the airport, the AOA is defined as follows and includes the following areas.

- Air Operations Area (AOA) - Means a portion of an airport, specified in the airport security program, in which security measures are carried out. This area includes aircraft movement areas, aircraft parking areas, loading ramps, and safety areas, and any adjacent areas (such as general aviation areas) that are not separated by adequate security systems, measures, or procedures. At ERI this is generally the area inside the AOA perimeter fence.
- Movement Area - The runways, taxiways, and other areas of an airport that are used for taxiing or hover taxiing, air taxiing, takeoff, and landing of aircraft, exclusive of loading

aprons and aircraft parking areas. At ERI movement areas (runways and taxiways) are under the control of the Airport Traffic Control Tower (ATCT) during the ATCT operating hours of 0600 to 0000 (6:00AM to 12:00AM).

- Non-Movement Area - The area inside the airport security fence exclusive of the Movement Area. It is important to note that the non-movement area includes areas of pavements traversed by aircraft.

Contractor access and operations within these areas are discussed in the following sections.

a) Construction Site Access and Haul Roads

1. Haul roads to be used on this project are indicated on the drawings or otherwise specifically authorized by the designer and Airport. The Contractor shall confine all vehicles and equipment to the designated construction areas, staging areas and haul routes.
2. Access points to the project work are shown on Sheet G-081 (Appendix A). The airport AOA security line shall be maintained at all times.
3. The Contractor shall restore all turfed and paved areas used for haul roads to their original condition, including establishment of new turf. All costs for constructing, removing, and restoring of haul roads required for the completion of the work shall be borne by the Contractor. The existing condition of all anticipated haul routes shall be documented prior to hauling.
4. The Contractor shall not permit any unauthorized construction personnel or traffic on the project site. The Contractor shall be responsible for traffic control at the project sites.
5. The Contractor shall be responsible for handling all material orders for delivery to the site.
6. It shall be the Contractor's responsibility to coordinate the use of off-site routes (state highways, county roads or city streets) with the appropriate owner who has jurisdiction over the affected route.
7. All vehicles using haul routes including off-site routes, shall be covered to prevent blowing away or spillage of loose material. All spillages on public roadways and site roads shall be promptly cleaned up and legally disposed of at no additional cost to the Airport.
8. The Contractor will not be permitted to use any access or haul roads other than those designated on the contract drawings. Aircraft Rescue and Fire Fighting (ARFF) right-of-way on access roads, haul roads, aprons, taxiways, and runways shall not be impeded at any time.
9. Flaggers for contractor crossing(s) of controlled movement areas are not anticipated for this project.

b) Contractor Staging Area

1. The limits of construction, Contractor's staging area and stockpile areas required for the Contractor's exclusive use during construction are shown on Sheet G-081 (Appendix A). Additional areas may be requested by the Contractor and approved by ERI. The Contractor shall provide devices visible for both day and night use to delineate the perimeter of all such areas.
2. Contractor shall utilize existing gravel or paved areas or install a minimum 3" thick graded and compacted gravel bed to the limits of the Contractor staging area that is not asphalt or concrete pavement. The Contractor shall protect all existing drainage structures from any damage caused while the area is being used as a construction staging area. All damage shall be repaired to the satisfaction of the Airport and at no additional cost to the Airport. A staging area layout plan shall be submitted to ERI and the designer for review and approved prior to construction.
3. The Contractor shall not park equipment or store materials within 6 feet of AOA fence.
4. The Contractor shall maintain existing drainage patterns at the staging and stockpile areas and provide temporary routing of storm water around the areas, cost shall be incidental to mobilization.

5. If necessary, in order to prevent sediment from leaving the batch plant (if used) and Contractor staging areas, the Contractor shall install temporary silt fence around the staging area and provide inlet protection devices for all existing drainage structures.
6. If necessary, all erosion control measures within the Contractor staging area shall be incidental to mobilization.
7. Contractor shall inform the construction admin team's field representative on a daily basis of the daily construction activities.
8. If necessary, the Contractor shall provide temporary utilities to the site, including water and electric for a batch plant and/or concrete crusher, if utilized by Contractor. All costs associated with temporary utilities shall be incidental to mobilization and general conditions. Not anticipated for this project.
9. All staging areas shall be inspected and approved by Airport's Fire Marshall. The Contractor shall supply any and all firefighting equipment, protection and safety equipment/supplies as requested by the Airport's Fire Marshall within 24 hours after requested.
10. Contractor shall supply covered trash and rubbish dumpsters and all other containers for removal of trash, rubbish, and debris resulting from the work of the contract. The Contractor should not allow dumpsters to overflow.
11. The Contractor shall completely clean up and restore the entire staging and storage areas, as approved by ERI prior to final completion. All unused materials shall be removed from the project site at the Contractors expense, unless prior approval has been given from the Airport and the staging area graded smooth, sloped to drain and seeded. Incidental to mobilization and general conditions.

c) Contractor Employee and Equipment Parking

1. All contractor vehicles shall be parked and serviced in the designated staging areas shown on Sheet G-081 (Appendix A).
2. All materials and equipment when not in use shall be placed in approved areas where they will not constitute a hazard to aircraft operations and not penetrate clearance height restrictions as shown on Sheet G-081 (Appendix A). All equipment shall be parked in the appropriate area(s) when not in use.

d) Vehicle Condition

1. Vehicles and equipment that are deemed a potential hazard by the designer or Airport shall be removed from the job site and airport property at the request of the designer. Vehicles and equipment that leak any automotive fluid including, but not limited to, oil, hydraulic fluid, transmission fluid, gear oil, gasoline, and diesel will be removed to the staging area and not allowed to operate on any paved surface. If the vehicle cannot be repaired within three days the vehicle shall be removed from the airport.
2. The Contractor shall cleanup, at Contractor's expense, any and all leaks or spills. Leaks on paved surfaces shall be cleaned up immediately. Significant leak spots on pavement, as determined by the designer, shall be replaced with new pavement. Asphalt will require milling and placement of new bituminous material; PCC will require saw, removal and repair as directed by the designer. Dirt or gravel areas will require removal, legal disposal and replacement of the area with similar approved materials

e) Location of Stockpiled Materials

1. There shall not be any stockpiled materials in the active runway OFA, taxiway OFA, or NAVAID critical areas. Stockpiled material or equipment shall not be stored near aircraft turning areas or operational movement areas, aprons, or excavations and trenches, or within 10 feet of AOA fencing. Stockpiled materials shall not be stored near navaids, visual or approach aids, nor shall they obstruct the ATCT's line of sight to any runway or taxiway. The Contractor shall ensure that stockpiled materials do not cause degraded or hazardous conditions to airport operations safety. This includes determining and verifying that stockpiled materials are stored at an approved location, that they are properly stowed to prevent foreign object debris (FOD), attraction by wildlife, or obstruction of air operations either by their proximity to navaids or to aircraft movement areas.
2. All stockpiled material/supplies shall be constrained in a manner to prevent movement resulting from aircraft blast or wind conditions. Material(s)/supplies shall not be stored within 500 feet of aircraft turning areas or movement areas. Stockpiled material(s)/supplies shall not exceed 15 feet in height unless the Contractor has complied with all requirements for FAA airspace review and secured approval from FAA or ERI Airport. All material(s)/supplies shall be positioned so it will not obstruct the line of sight from the control tower to the movement area. Marking and lighting shall be in accordance with the requirements contained in barricade details checklist.

f) Vehicle and Pedestrian Operations

1. Vehicle and access routes for airport construction shall be controlled as necessary to prevent inadvertent or unauthorized entry of persons, vehicles or animals onto air operation areas. No vehicle shall enter the air operations area except at predetermined locations.
2. All construction vehicles/mechanized equipment authorized within the airfield perimeter shall be marked with an amber beacon or a clean 3' x 3' orange and white checkered flag with each box being 1' square, located on the uppermost portion of the vehicle/motorized equipment; or be escorted by a vehicle so equipped. During nighttime hours or periods of low visibility all operating vehicles shall be marked with a beacon.
3. During nighttime hours, all equipment operating on the airport exceeding 15 feet in height shall be lit with a red obstruction light located on the uppermost portion of the equipment.
4. Vehicles/mechanized equipment authorized on the aircraft movement areas (runways & taxiways) and/or associated safety areas shall be equipped with an electrically powered, amber color, 360-degree omni-direction light, mounted on the vehicle such that it is conspicuous from any direction. Movement areas are aircraft runways and taxiways that are under the control of the Airport Traffic Control Tower (ATCT).
5. ARFF and other emergency vehicle traffic shall have precedence over Contractor vehicles at all times. Blockage of existing designated ARFF routes is prohibited.

g) Required Escorts

1. It is the Contractor's responsibility to designate employees with a photo airport ID, properly trained by ERI for AOA driving and escorting, and properly equipped vehicles to be responsible for the escorting of all contractors/vendors/suppliers requiring access to the construction site within the AOA. These individuals will be knowledgeable in all applicable airport security, safety, AOA driving rules and regulations. The names of these individuals will be provided to the airport operations/security manager.
2. The Contractor must provide an appropriately trained and authorized escort for any vehicle or equipment on the aircraft movement areas or within the AOA fence, if so authorized for such operations by the Airport. Each escort may accompany a maximum of 5 vehicles at a time across movement areas.
3. During any absence of the approved escort(s) or for periods that they are unable to perform their specified duties, all work within the movement area and associated safety areas for projects shall

stop. Additionally, all personnel and equipment shall be escorted to approved locations outside the movement area and related safety areas. No contract time extension will be granted for time lost due to the absence of escort(s). Work shall resume only with the return of the approved escort(s).

4. The escort shall assure that all equipment maintains proper clearances from moving aircraft and remains within approved locations.
5. Vehicular traffic crossing active movement areas must be controlled either by two-way radio with the ATCT, escort, flagmen, or other means appropriate for the particular crossing.
6. If authorized by Airport Operations for two-way radio communications with the ATCT the following frequency shall be used: ERIE GROUND 121.9 (0600-0000). Outside of ATCT hours of operation, the CTAF 118.1 and UNICOM 122.95 frequency shall be used to monitor and coordinate traffic with aircraft operations. The contractor shall use proper radio usage, including read back requirement, proper phraseology, including the international phonetic alphabet.

h) Badging and Training Requirements for Employees and Vehicle Drivers

1. All Contractor personnel working within the AOA shall possess and appropriately display an Airport Identification Badge. Applicants will be required to attend an airport training course on airport security and AOA driving safety training (for those requiring AOA driving privileges) and pass a short test. Two pieces of identification are required for badge issuance, one of which must be a government or school issued photo ID. The contractor shall contract the Airport for scheduling the required training for an AOA access badge and AOA driving privileges, for information regarding the times training is offered, and the costs for training and badges.

i) Maintenance of the Secured Area of the Airport

1. Special access requirements and operating limitations are required inside the security fence. The Contractor shall delineate work limits within these areas as per Sheet G-081 (Appendix A). Confine men, equipment and materials outside of the runway safety area (RSA) when runway is active. Confine men, equipment and materials outside of the taxiway object free area (TOFA) when the taxiway is active.
2. The Contractor shall have access to the airport only at those locations designated on Sheet G-081 (Appendix A). All other access shall be by special request and subject to approval by the Airport.

210) Wildlife Management

1. Contractor shall instruct employees not to discard food or other trash on or around work sites that could attract wildlife. Contractor employees shall not intentionally feed any wildlife while working at the airport.
2. Contractor shall properly seal all trash containers at work sites such that wildlife cannot gain access to containers during non-construction periods.
3. Contractor shall notify Airport Operations staff if large numbers of birds are observed at work sites. Contractor shall immediately notify operations staff if deer are sighted within the airfield fence.
4. Contractors must carefully control and continuously remove waste or loose materials that can create wildlife hazards or attractants. These include trash, standing water, tall grass, scattered seeds, poorly maintained fencing, and disruption of existing habitat.

211) Foreign Object Debris (FOD) Management

1. The Contractor shall have available upon request of ERI Operations a vacuum type mechanical sweeper and water truck to clean all taxiway and apron pavement of dirt, stones, and loose debris from airport paved surfaces, that result from the contractor's operations. No direct pay will be made for vacuum and water trucks or for pavement cleaning.

2. No debris shall be allowed to remain on the roadways or airport paved surfaces. Active taxiways and aprons shall be kept free of debris at all times. Payment for vacuum sweeping and cleaning of runways, taxiways and/or aprons is incidental to other items in this contract.
3. The Contractor shall have available upon request of ERI Operations a method of periodic spraying of any stockpile or exposed areas to limit dust.

212) Hazardous Materials (HAZMAT) Management

1. Hazardous materials can be easily identified using the U.S. Department of Transportation (DOT) labeling and identification system. All hazardous materials arriving on site must be properly labeled, stored, and managed as required by the material safety data sheet (MSDS) for that material, or as directed by Erie International Airport (ERI) Fire, ERI Environmental and ERI Risk Management.
2. All wastes shall be properly stored, labeled, managed, and disposed of in accordance with Airport project specifications and State and Federal regulations, or as otherwise directed by the Airport environmental personnel.
3. Contractors and subcontractors are required to have copies of all MSDS's for all materials brought on site.
4. If suspect unknown hazardous materials are identified, then the job should stop until further direction by the ERI environmental and risk management departments.
5. If potentially hazardous waste/materials have been indicated in the bid documents and could be foreseen in a project, proposal, or work order, then the Contractor is expected to have onsite the proper personal protective equipment and instruments for detection and safety.
6. Projects that include abatement or remediation must have their own specific job plans.
7. Contractor must immediately report spills to Airport staff and appropriate state departments. Reports are to conform to state requirements.

213) Notification of Construction Activities

1. Prior to commencement of construction activity, the Contractor shall notify in writing, at least 5 days in advance, Airport staff and the Engineer of its intentions to begin construction, stating the proposed time, date, and area of which construction is to occur in order for the appropriate notice-to-airmen (NOTAM) to be issued. During the performance of this contract, the airport facility shall remain in use to the maximum extent possible. The Contractor shall not allow employees, subcontractors, suppliers, or any other unauthorized persons to enter in any airport area which may be open for aircraft use, except as noted on Sheet G-081 of Construction Safety Phasing Plan drawings (Appendix A).
2. Contractor shall inform the designer's field representative on a daily basis of the daily construction activities.
3. Responsible representative/points of contact
 - A. Airport
 - Airport Police/Security – Ian Bogle (814) 450-3824
 - Airport Police – Non-Emergency – (814) 397-9911
 - Airport Operations – Brad Wargovich (814) 450-3798
 - Airport Fire - Emergency Response - 911
 - Airport Fire - Non-Emergency – Chris Karotko (814) 450-0081
 - Airport Manager – Derek Martin (814) 835-4156
 - B. Resident Project Representative / Engineer
 - Byron Henicle
 - Mead & Hunt, Inc.
 - (971) 256-9307
 - C. Contractor
 - TBD

4. NOTAMs

In order for the Contractor to operate within airport property, appropriate notices to airmen (NOTAM) must be issued by ERI. These notices provide information on closed, limited, or hazardous conditions to airmen and users of the airport. A minimum 72-hour notice is required for issuance of the proper NOTAM, all construction operations must be closely coordinated with ERI Operations for NOTAM issuance.

5. Emergency Notification Procedures

- A. The Contractor shall immediately call 911 if an accident occurs with injuries on airport property advising the location is on Erie International Airport for them to coordinate with the Airport.
- B. After notifying 911, the Contractor shall also immediately notify Airport Operations/Security.
- C. Within 24 hours, the Contractor shall report all accidents to Airport Airfield Operations and the Construction Management Team.

6. Coordination with ARFF

- A. If a fire occurs on Airport Property, the Contractor shall not attempt to fight the fire beyond what may be doused by use of a fire extinguisher. The Contractor shall immediately call 911 advising the location is on Erie International Airport for them to coordinate with the Airport.
- B. After notifying 911, the Contractor shall also immediately notify Airport Operations.
- C. Non-emergency communication with ERI Airport ARFF will be coordinated by the Airport Construction Administration Team.
- D. A ERI ARFF representative will be invited to attend the preconstruction conference at which time the overall construction schedule will be presented.
- E. A meeting will be scheduled with the ERI ARFF representative prior to the start of each major construction phase which significantly impacts/modifies airfield closures throughout the duration of the construction project. Participants in these meetings shall include: Airport Staff, Airport Operations, Design Team, Construction Administration Team, Contractor, and Subcontractors.

7. Notification to the FAA

- A. The Contractor's use of cranes, boom trucks, concrete pump trucks, drill rigs and other tall objects will require submittal and approval by the Airport and Engineer. Dependent on the location and usage, the equipment may require FAA airspace review as submittal on FAA Form 7460-1 notice of construction, which could take up to 90 days.
- B. If Contractor requires equipment in excess of maximum allowable height, they must submit a 7460-1 90 days in advance of crane erection. All construction involving cranes shall further be coordinated at least 5 days in advance, excluding weekends, with the ERI Staff. This does not include the time required for airspace review. The following information and actions are required:
 - Location of the crane (latitude and longitude).
 - Maximum extendable height.
 - Hours of operation.
 - The top of each crane boom shall be marked by a 3' x 3' orange and white checkered flag -- each box being 1' square.
 - Each crane shall be lowered at night and during periods of poor visibility as directed by Airport airfield operation units or Airport Facilities Planning, Design and Construction. In the event the crane is approved to remain extended during the hours from sunset to sunrise, the highest point of the crane boom will be lit with a red obstruction light in accordance with AC 70/7460-1.

8. The Airport will submit to the FAA for approval a notice of construction (7460-1) for the areas of construction (25 feet in height) as shown on Sheet G-081 (Appendix A).

214) Inspection Requirements

1. Construction Equipment: The Contractor shall inspect all construction equipment on a daily basis to ensure that the equipment is in good working order and that orange and white construction flags and/or operational beacons are present, clean, and in good condition.
2. Construction Barricades: The Contractor shall inspect all construction barricades on a daily basis to ensure that barricades are in good condition and that flashing beacons are in working order. If barricades are damaged, they shall be removed from the construction site and replaced immediately. Any inoperable flashing lights will be removed and replaced at the end of every day.
3. Construction Equipment Fueling Area: The Contractor shall inspect the construction equipment fueling area daily. Any fuel spills will be reported to ERI Airport Operations as soon as spill has been identified. If temporary fuel tanks are supplied by the Contractor, they must be surrounded by concrete jersey barriers. Also, tanks must be marked flammable on all sides and labeled with the type of fuel they contain.
4. Active Airport Pavements within Construction Site: The Contractor shall inspect all active airport pavements within the construction site continuously during construction activities. Materials tracked onto active airport pavements must be continuously removed during the project. Prior to leaving the construction site at the end of each day, the Contractor must contact ERI Airport Operations for an inspection of the cleanliness of airport pavements.
5. The Airport Operator shall conduct additional self-inspections in the vicinity of the project with special emphasis on the presence of FOD that could damage aircraft. All construction areas must be inspected by airport management in accordance with 14 CFR Part 139 prior to reopening to air carriers. Inspections will be conducted of all areas to be reopened to aircraft traffic to ensure the proper operation of lights and signs, for correct markings, and absence of FOD. The Contractor shall immediately correct any deficiencies for areas open (or about to be opened) to aircraft operations associated with the Contractor's work or operations.
6. A final FAA safety inspection may be required prior to allowing aircraft operations through the area. Coordination with the FAA Airport Certification Safety Inspector will determine if a final FAA safety inspection will be necessary.

215) Underground Utilities

1. The Contractor shall identify any known underground interferences or discrepancies on all available drawings that can be provided by contacting the Designer and Airport.
2. Prior to commencing any excavation (on or off AOA), drilling (on or off the AOA), driving fence posts (along the AOA), trenching (on or off the AOA), saw cutting (AOA only), the Contractor shall review drawings with Airport personnel to ensure that all underground obstructions and utilities are identified. In addition, the Contractor shall contact PA One Call and coordinate with the Airport to assign the marking of utilities by the Airport. PA ONE CALL, FAA, and the Contractor shall attempt to locate utilities. The Contractor will be completely responsible for all damage to underground utilities. The Contractor shall coordinate request for marking utilities at least 72 hours prior to any excavations. One utility marking of the identified area is covered under contract. The Contractor shall not proceed until the utility markings have been completed by the appropriate agencies. If the utility markings encompass more than 5,000 linear feet or one acre, the request shall be made at least two weeks prior to the start of construction. Airport will notify the Contractor a minimum within 24 hours after receiving notice, at that time the Airport will indicate if it can complete the utility marking. If it can't, the Contractor will be responsible to complete the utility marking and/or use PA ONE CALL.
3. After the area has been successfully marked for utilities, the Contractor shall properly complete, sign, date, and distribute the field acknowledgement form. Contractor may not commence excavation without an executed field acknowledgement form.
4. Each utility shall be marked in the following manner:

- A. Flags can be used but shall be color coordinated as suggested below. In addition, the “acronym” for that utility shall be written on one side of the flag with a permanent marker.
 - B. Stakes can be used. The top two inches of the stake shall be painted in color as suggested below. In addition, the “acronym” for that utility shall be written on one side of the stake with a permanent marker.
 - C. Painting is only authorized on asphalt, concrete, and metal surfaces. Markings shall be color coordinated as suggested below. The acronym for the utility shall be used for each utility. A line that shows the direction of the utility shall emanate from the acronym in each direction.
5. All marking of utilities shall be every 50 feet.

	<u>Acronym</u>	<u>Color</u>
Electrical loops (non-AOA)	use “ELEC”	red
Airfield Electrical	use “ELEC”	red
Natural Gas	use “NAT GAS”	yellow
Sanitary	use “SANIT”	brown
Storm	use “STORM”	brown
Combined Sewers	use “COMBO”	brown
Water (potable and fire)	use “WATER”	blue
FAA Copper	use “FAA COP”	red
FAA Fiber	use “FAA FIB”	orange
ERI Fiber	use “FIBER”	orange
Telephone	use “TELE”	orange
Jet Fuel	use “JET FUEL”	yellow
Glycol	use “GLYCOL”	blue
Oil	use “OIL”	yellow
Gasoline	use “GAS”	yellow
Diesel	use “DIESEL”	yellow
Steam	use “STEAM”	black
Condensate	use “CONDEN”	black

- 6. If underground utility is abandoned, Contractor shall still stake, mark, or flag but write down “ABAND” before the abbreviated prefix indicated above.
- 7. The individual marking, staking, or flagging shall mark the utilities in a way that coincides with the drawings that are referenced on the request for marking utilities form.
- 8. If a utility or any underground obstruction is found it shall be reported immediately to the designer or the Airport staff.
- 9. Contractor employees in an excavation shall be protected from cave-ins by an adequate protective system unless the excavation is:
 - A. Made entirely of stable rock, or
 - B. Less than 5 feet deep and determination has been made that there is no potential for a cave-in.
- 10. Excavation shall be protected using proper barricading materials which shall be installed a minimum of 6 feet back from excavation (unless in conflict with airfield requirements). Barricade material can be wood, steel cables, or chain supported at intervals so that the barricade does not sag or droop below the required height. Caution tape is not an approved barricade material. Guardrail/jersey barriers may be required and shall provide a top rail, mid rail, and toe board at proper elevations and be able to withstand a minimum 200 pound force without collapsing.
- 11. The Contractor is responsible for documenting utility information for use during construction and preparation of as-builts.

12. Should the Contractor need additional utility markings to be performed by the Airport, the Contractor shall submit a new request for marking utilities. If the marking of an area already marked is requested, the Contractor shall be responsible for all associated costs of the subsequent marking(s), including time for Airport personnel.

216) Penalties

Continuous surveillance shall be maintained to ensure that only authorized vehicles and persons are on the airfield operations area. Rules, regulations, and procedures are outlined and in place to ensure the safety of the AOA and entities throughout the airport. Any violations to the rules, regulations, and procedures regarding this project will fall under the responsibility of the Contractor and its subcontractors. The Contractor shall be responsible for any and all fines that may be assessed either to them or ERI as a result of negligence or non-compliance with the rules, regulations, procedures and safety plans in relation to this project. Severity of fines or disciplinary actions may include suspension or termination of badged employees AOA driving privileges, access to the AOA, or monetary fines.

217) Special Conditions

Special conditions may impact the performance of work on the AOA. In these instances, the Contractor will be notified of the actions that must be taken by ERI Airfield Operations to ensure the safety of the airport and its employees.

1. During special events, aircraft emergencies, local area emergencies, VIP arrivals, and severe weather conditions, as designated by ERI Airfield Operations, the Contractor may be required to stop work and vacate the construction site. Contractors must take all precautions to ensure construction material or debris does not become FOD and pose a hazard to the safety of aircraft or employees working on or adjacent to construction project. Contractors should have means of notifying employees of emergencies, severe weather, and evacuation plans if necessary.
2. Winter Conditions: As much as possible ERI will allow construction activities through the winter season. However, snow removal operations take precedence over all other activities during this time frame. A Contractor may be notified in short notice of cancellation or termination of work. It is the Contractor's responsibility to coordinate their activities with airport snow removal operations to limit shutdowns of the Contractor's work operations to the extent possible.

218) Runway and Taxiway Visual Aids

1. Taxiway A edge lighting shall be disconnected in closed sections of the taxiway and maintained in operation in areas open to aircraft. This will require temporary jumpers and the contractor shall provide a temporary jumper plan as indicated on Sheet G-081 (Appendix A).
2. Runway and taxiway visual aids, including runway lighted closure cross or any temporary runway and/or taxiway pavement marking will be as shown on the CSPP drawings and provided by the Contractor. All permanent and temporary markings will be in compliance with the current edition of FAA AC 150/5340-1, *Standards for Airport Markings*. All permanent and temporary lighting and signage will be in compliance with FAA AC 150/5340-30, *Design and Installation Details for Airport Visual Aids*, FAA AC 150/5345-50, *Specifications for Portable Runway Taxiway Lights*, FAA AC 150/5345-44, *Specification for Runway and Taxiway Signs*, FAA AC 150/5340-18, *Standards for Airport Sign Systems*, and FAA AC 150/5345-53, *Airport Lighting Certification Program*.
3. When aircraft operation areas must be closed, the Contractor shall furnish and place portable barricades across runways or taxiways to keep vehicles from entering active operation areas and to keep aircraft from taxiing into construction areas. Excavation and open trenches may be permitted up to the edge of an apron provided the drop off is appropriately marked and lighted. Barricades shall be marked with diagonal, alternating orange and white stripes and supplemented with either flashing or steady-burning lights during hours of restricted visibility or darkness. Lights

shall be barricade type typical for construction zones, and red in color. All lights must be checked nightly to ensure that they are operating. Any lights not functioning shall be immediately replaced.

All centerline markings leading into closed sections of the airfield will be obliterated for closures lasting longer than 30 days.

Existing signs that are within and leading into closed sections of the airfield shall have the panels removed and replaced with blank panels. Existing lights that are within closed sections of the airfield shall be either covered or removed from the active airfield circuit. Signs and lights shall be approved by ERI staff.

Barricades located within aircraft operation areas shall be low level aviation barricades specifically manufactured and designed for such purpose. They shall be alternating orange and white in color <18" high and 96" long, made of UV-resistant polyethylene as manufactured by multi-barrier (model AR 10x96 HDPE) or approved equal.

All barricades, closure crosses, etc. shall be weighted down as approved by the Airport Staff.

219) Marking and Signs for Access Routes

1. As noted on Sheet G-081 (Appendix A), access to the site will be from Powell Ave. The Contractor shall install construction entrance roadway signage as required by Mill Creek Twp and in compliance with Manual of Uniform Traffic Control Devices (MUTCD).
2. Markings and signs used on access routes shall conform to FAA AC 150/5340-18 *Standard for Airport Sign Systems* and, to the extent practicable, with the most current version of the Manual of Uniform Traffic Control Devices (MUTCD).

220) Hazard Marking and Lighting

a) Hazard marking

Hazard-marking barricades, traffic cones, flashers, etc. Should be used: to identify and define the limits of construction making them visible to aircraft, personnel, or vehicles; to identify hazards such as open manholes, small areas under repair, stockpiled material, waste areas, etc.; to prevent aircraft from taxiing onto a closed taxiway; and to identify FAA, airport, and national weather service facilities, cables, power lines, instrument landing system (ILS) critical areas, and other sensitive areas to prevent damage, interference, and facility shutdown. Hazardous areas, in which no part of an aircraft may enter, should be indicated by the use of barricades marked with diagonal, alternating orange and white stripes. The barricades should be supplemented with alternating orange and white flags and installed so that they are always in the extended position and properly oriented. During reduced visibility or night hours, the barricades should be supplemented with flashing red lights. The intensity of the lights and spacing for barricades, flags, and lights should be adequate to delineate the hazardous area without ambiguity. The Contractor shall have a designated person on call 24-hours a day for emergency maintenance of airport hazard lighting and barricades.

b) Marking and Lighting

All construction areas, should be clearly and visibly separated from active air operation areas. Hazard areas, facilities, cables, and power lines should also be clearly identified by the Contractor. The Contractor is responsible for maintaining the condition and visibility of all markers identifying above-mentioned areas and that marking and lighting aids remain in place. Alternating orange and white flaglines, traffic cones, omnidirectional yellow flashers, and/or signs should be used as necessary to clearly separate all construction/maintenance areas from other parts of the AOA.

c) Equipment**Delineating work areas**

1. In accordance with Sheet G-081 (Appendix A), OSHA guidelines, the contractor's safety program, and/or upon request of ERI, construction barricades or safety fence shall be furnished and installed to delineate the contractor's work areas.
2. If used, Safety fence shall be 30-pound high density polyethylene (HDPE) international orange fence fabric wired securely to supports that do not damage any pavements.
3. Low level barricades should conform with Sheet G-086 (Appendix A) and other barricades, if used, the most current version of the Manual of Uniform Traffic Control Devices (MUTCD).

221) Work Zone Lighting for Nighttime Construction

Lighting equipment must adequately illuminate the work area if the construction is to be performed during nighttime hours. Refer to the current versions of FAA AC 150/5370-10 *Standard Specifications for Construction of Airports* for minimum illumination levels for nighttime paving projects. Additionally, it is recommended that all support equipment, except haul trucks, be equipped with artificial illumination to safely illuminate the area immediately surrounding their work areas. The lights should be positioned to provide the most natural color illumination and contrast with a minimum of shadows. The spacing may need to be determined by trial. Light towers should be positioned and adjusted to aim away from ATCT cabs and active aircraft movement areas to prevent glare or blinding effects. Note that shielding of light fixtures may be necessary to prevent glare or blinding effects. Light towers should be removed from the construction site when the area is reopened to aircraft operations.

222) Protection of Runway and Taxiway Safety Areas

The project requires construction activity within the critical areas of closed runways and taxiways. The following describes the requirements and procedures for runway and taxiway safety and object free areas, runway obstacle free zone, and approach and departure surfaces as stated in the FAA AC 150/5300-13B *Airport Design*.

Runway and taxiway safety areas provide a safe area adjacent to active pavements to allow aircraft to maneuver in the event of an emergency and the aircraft leaves the pavement. For this reason all safety areas must remain free of excavations, elevation changes greater than 3" (up or down) and storing, staging or stockpiling of any material or equipment. Safety areas must be protected during all construction activities and comply with all FAR Part 139 Standards. Any work within a safety area must be coordinated through the Engineer and ERI Operations. Work will only be permitted in these areas when a runway or taxiway is closed or restricted for a lesser aircraft design group.

a) Runway Safety Area (RSA)

Equipment, open trenches, excavations and other construction activities within the RSA are not anticipated with this project. Under no circumstances are these activities permitted within the RSA while the runway is open. Runway Safety Areas at ERI for all runways are 500' in width (250' from runway centerline). **Runway Object Free Area (ROFA)** Construction activities within or near the ROFA are anticipated with this project. Runway Object Free Areas at ERI for Runway 6-24 are 800' in width (400' from runway centerline) and for Runway 2-20 are 150' in width (75' from runway centerline). No stockpiles shall be placed within the ROFA while the runway is active.

b) Taxiway/Taxilane Safety Area (TSA)

Equipment, open trenches, excavations or other construction activities within the Taxiway A TSA are anticipated with this project. These activities are not permitted within the TSA while the taxiway in that area

is open. Taxiway Safety Areas vary according to Aircraft Design Group (ADG) in accordance with the following table. Taxiway A at ERI is ADG III.

Taxiway/Taxilane Aircraft Design Group (ADG)	TSA Width	TSA Distance from Centerline
I	49'	24.5'
II	79'	39.5'
III	118'	59'
IV	171'	85.5'
V	214'	107'

c) Taxiway/Taxilane Object Free Area (TOFA)

Work within the TOFA is more restrictive than a ROFA due to the potential of an aircraft wingtip penetrating this area. Specific to this project, work is anticipated within a TOFA and sections of Taxiway A will be closed. Vehicular traffic entering open portions of the TOFA and any active movement areas must be controlled either by two-way radio with the ATCT, escort, flagmen, or other means appropriate for the particular activity. No parking or servicing of equipment will be permitted within an active TOFA. Unlike the TSA, TOFA distances and widths are different for taxiways and taxilanes. Taxiway A is ADG III.

Taxiway/Taxilane Aircraft Design Group (ADG)	TOFA Width (Taxiway/Taxilane)	TOFA Distance from Centerline (Taxiway/Taxilane)
I	89' / 79'	44.5' / 39.5'
II	124' / 110'	62' / 55'
III	171' / 158'	85.5' / 79'
IV	243' / 224'	121.5' / 112'
V	285' / 270'	142.5' / 135'

d) Obstacle Free Zone (OFZ)

Construction activities within an OFZ are not anticipated with this project. The contractor shall remain clear of all Obstacle Free Zones, at least 200' from runway centerlines.

e) Runway Approach/Departure Surfaces

Construction activities are not anticipated within the approach and departure surfaces of the Airport's runways.

223) Other Limitations on Construction

a) Prohibitions.

- A. Open flame welding or torch cutting operations are prohibited unless adequate fire and safety precautions are provided and have been approved for use by the designer and a burn permit has been obtained from the ARFF.
- B. Flare pots shall not be used near aircraft turning areas.
- C. Electrical blasting caps shall not be used within 1,000 ft of the airport property.

Appendix “A”
Construction Safety Phasing Plan Drawing

POINTS											
POINT LABEL	LATITUDE	LONGITUDE	ELEVATION	AGL (FT)	DISC.	POINT LABEL	LATITUDE	LONGITUDE	ELEVATION	AGL (FT)	DISC.
A	N42° 04' 55.39"	W80° 10' 35.82"	729.6'	25'	TWY CONST.	K	N42° 04' 52.64"	W80° 10' 41.56"	729.27'	25'	TWY CONST.
B	N42° 04' 56.24"	W80° 10' 31.37"	727.67'	25'	TWY CONST.	L	N42° 04' 52.15"	W80° 10' 42.50"	729.05'	25'	TWY CONST.
C	N42° 04' 58.15"	W80° 10' 24.65"	729.21'	25'	TWY CONST.	M	N42° 04' 51.79"	W80° 10' 42.61"	729.09'	25'	TWY CONST.
D	N42° 04' 57.84"	W80° 10' 24.36"	729.69'	25'	TWY CONST.	N	N42° 04' 52.04"	W80° 10' 39.28"	727.28'	25'	TWY CONST.
E	N42° 04' 52.38"	W80° 10' 34.64"	730.68'	25'	TWY CONST.	O	N42° 05' 04.68"	W80° 10' 32.60"	732.55'	25'	STAGING AREA
F	N42° 04' 49.09"	W80° 10' 40.82"	730.61'	25'	TWY CONST.	P	N42° 05' 05.92"	W80° 10' 29.06"	732.55'	25'	STAGING AREA
G	N42° 04' 50.13"	W80° 10' 42.87"	728.9'	25'	TWY CONST.	Q	N42° 05' 05.05"	W80° 10' 28.50"	726.23'	25'	STAGING AREA
H	N42° 04' 49.86"	W80° 10' 45.36"	728.95'	25'	TWY CONST.	R	N42° 05' 03.81"	W80° 10' 31.98"	727.5'	25'	STAGING AREA
I	N42° 04' 53.38"	W80° 10' 44.52"	728.29'	25'	TWY CONST.	S	N42° 04' 58.56"	W80° 10' 24.43"	727.0'	25'	HAUL ROUTE
J	N42° 04' 52.84"	W80° 10' 41.75"	728.97'	25'	TWY CONST.	T	N42° 04' 53.38"	W80° 10' 35.80"	727.0'	25'	HAUL ROUTE

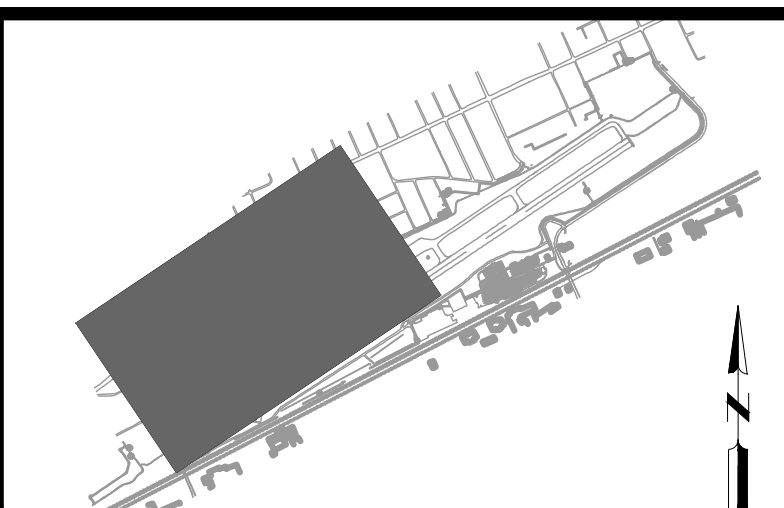

KEYMAP

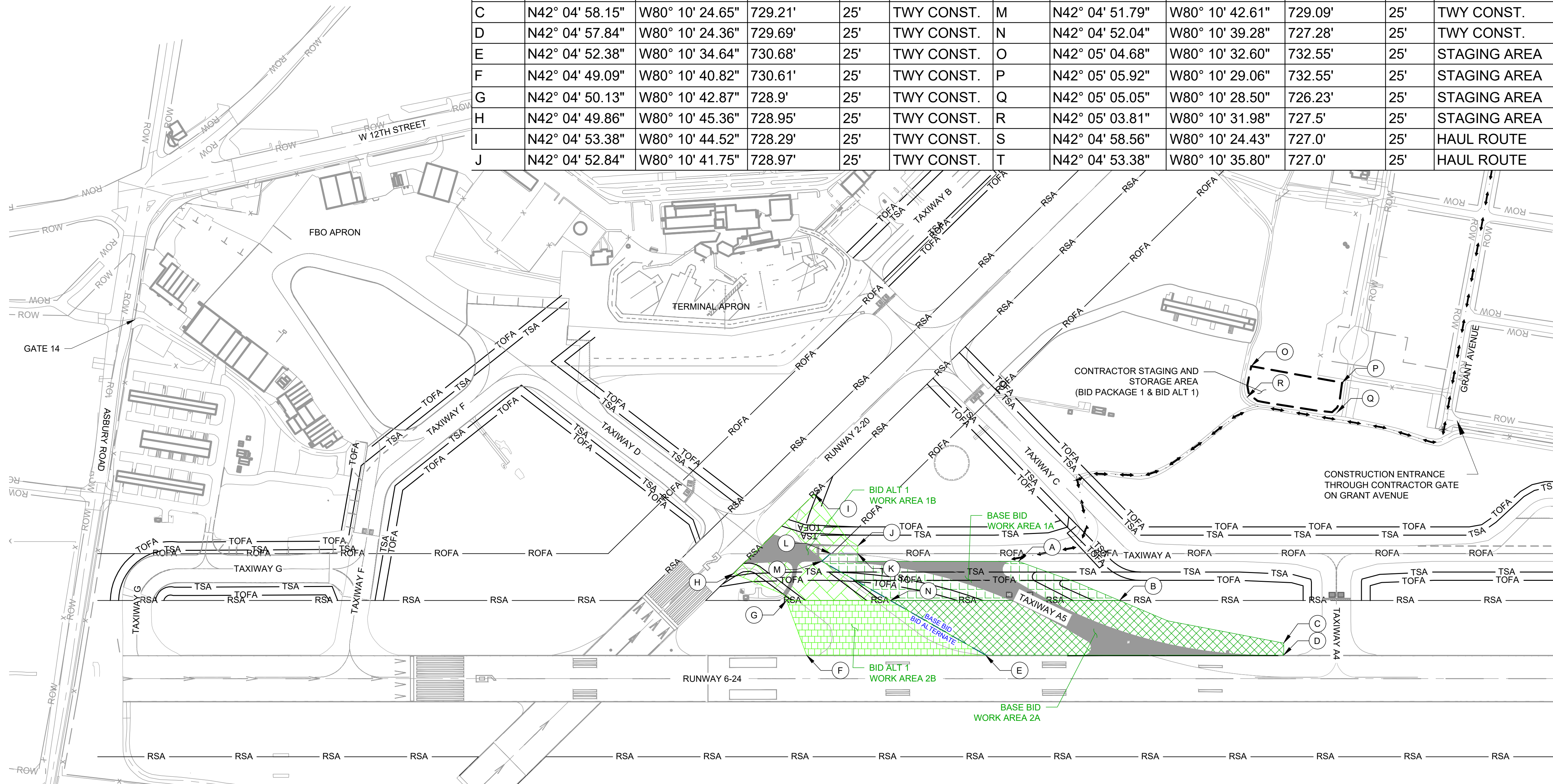
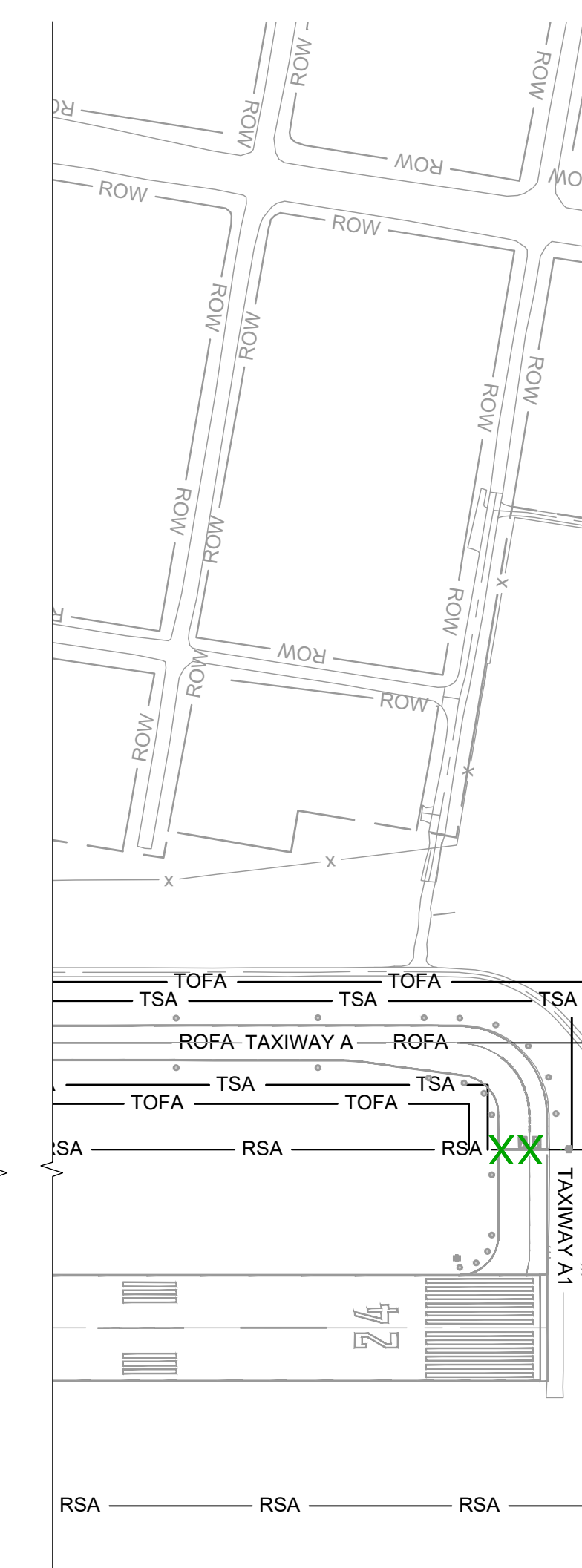

- GENERAL NOTES:**
- THE CONTRACTOR IS RESPONSIBLE FOR PLACEMENT AND REMOVAL OF BARRICADES. COORDINATE WITH THE RPR AND AIRPORT TO CONFIRM NOTAM'S ARE ISSUED AND APPROPRIATE RUNWAY AND TAXIWAY LIGHTING CIRCUITS ARE DISABLED.
 - THE CONTRACTOR SHALL LOCK OUT/TAG OUT ALL ELECTRICAL CIRCUITS TO CLOSED PAVEMENTS AND INSTALL TEMPORARY JUMPERS WHERE NECESSARY TO LIGHT OPEN PAVEMENTS. THE CONTRACTOR SHALL PROVIDE A TEMPORARY JUMPER PLAN 14 DAYS PRIOR TO WORK AREA CHANGE FOR APPROVAL BY THE RPR AND AIRPORT. ELECTRICAL LOCK OUT/TAG OUT AND TEMPORARY INSTALLATION SHALL BE INCIDENTAL TO MOBILIZATION.
 - THE CONTRACTOR SHALL REMOVE TAXIWAY CENTERLINES LEADING TO CLOSED TAXIWAY PAVEMENTS FOR ALL CLOSURES OVER 30 DAYS IN DURATION.
 - THE CONTRACTOR SHALL PROVIDE GATE GUARD(S) AT ALL CONSTRUCTION ENTRANCES. COORDINATE ADDITIONAL TRAINING WITH THE AIRPORT OPERATOR.
 - THE CONTRACTOR SHALL REQUEST A SAFETY AND LIGHTING INSPECTION BY AIRPORT OPERATIONS PRIOR TO LEAVING THE CONSTRUCTION SITE AFTER EACH WORKING DAY. THE SAFETY INSPECTION SHALL INCLUDE THE CONDITION OF ACTIVE OPERATION AREAS ADJACENT TO THE CONSTRUCTION LIMIT, THE CONDITION OF THE CONTRACTOR STAGING AREA, AND THE SECURITY OF THE CONSTRUCTION ENTRANCE(S). THE CONTRACTOR'S SUPERVISOR SHALL REMAIN ON SITE UNTIL THE SAFETY INSPECTION IS COMPLETE AND ALL DEFICIENCIES HAVE BEEN CORRECTED TO THE SATISFACTION OF THE AIRPORT OPERATIONS DEPARTMENT.
 - ACCESS TO THE SITE WILL BE FROM GRANT AVE. FOR BID PACKAGE 1 AND BID ALT 1. THE CONTRACTOR SHALL INSTALL CONSTRUCTION ENTRANCE ROADWAY SIGNAGE AS REQUIRED BY MILLCREEK TWP AND IN COMPLIANCE WITH MUTCD. CONTRACTOR SHALL OBTAIN ROADWAY PERMIT THROUGH MILL CREEK TOWNSHIP, ALL FEES SHALL BE INCIDENTAL TO PERMITS.
 - CONTRACTOR IS ADVISED OF SPECIAL EVENTS INCLUDING TALL SHIPS FESTIVAL IN AUGUST, AND DISCOVER PRESQUE IS IN JULY. CONTRACTOR SHALL COORDINATE WITH THE AIRPORT ON POTENTIAL IMPACTS THESE EVENTS HAVE ON CONSTRUCTION OPERATIONS.
 - CONTRACTOR TO COORDINATE WORK AREA 1A, 2A, 1B, AND 2B WORK WITH AIRPORT OPERATIONS. THE WORK WITHIN RUNWAY SAFETY AREA SHALL ONLY BE PERMITTED AT NIGHT BETWEEN THE HOURS OF 11:00 PM TO 5:00 AM, IN COORDINATION WITH AIRPORT OPERATIONS. ALLOWABLE WORK ONLY WHEN NO COMMERCIAL AIRCRAFT OPERATIONS ARE SCHEDULED. ALL WORK SHALL BE BACKFILLED TO MEET RSA REQUIREMENTS (NO DROPOFFS GREATER THAN 3") WITHIN THE WORK TIMEFRAME PERMITTED BY AIRPORT OPERATIONS. RUNWAY CLOSURE CROSSES SHALL PROVIDED BY AIRPORT. CONTRACTOR SHALL MAINTAIN, PROVIDE FUEL, AND SERVICE THE CLOSER CROSSES FOR HE DURATION OF CLOSURES.
 - TWO FLAGGERS SHALL BE PRESENT DURING ALL HAULING OPERATIONS THAT TAKE PLACE OVER ON ACTIVE TAXIWAYS. ONE SHOULD BE POSITIONED ON THE NORTH SIDE OF TAXIWAY C OUTSIDE OF THE TOFA ON THE ACCESS ROAD. ONE SHOULD BE AT THE ENTRANCE/EXIT TO THE WORK AREA. FLAGGERS SHOULD HAVE AIRPORT APPROVED RADIOS AND BE IN COMMUNICATION WITH THE GATE GUARD AND AIR TRAFFIC CONTROL.
 - A SWEEPER VAC TRUCK SHOULD BE ONSITE THROUGHOUT ALL HAULING OPERATIONS OVER ACTIVE TAXIWAYS. THE TRUCK SHOULD MAINTAIN CLEAN TAXIWAY SURFACES AND SHALL REMOVE ALL FOD FROM HAULING OPERATIONS
 - THE CONTRACTOR SHALL NOTIFY THE AIRPORT AT LEAST 5 DAYS IN ADVANCE OF WORK AND WORK AREA CHANGES SO THAT THE AIRPORT MANAGEMENT CAN ISSUE A NOTAM OF CONSTRUCTION ACTIVITY.
 - ALL GATES MUST BE LOCKED OR GATE GUARD POSTED.
 - ALL CONTRACTOR PERSONNEL WORKING ON-SITE SHALL UNDERGO AIRPORT TRAINING AND HAVE AIRPORT ISSUED BADGE.
 - MAXIMUM EQUIPMENT HEIGHT FOR THE PROPOSED WORK AREA IS 25' UNLESS OTHERWISE NOTED.
 - EACH WORK AREA WILL NEED TO BE SUBSTANTIALLY COMPLETE PRIOR TO STARTING WORK IN THE NEXT WORK AREA.

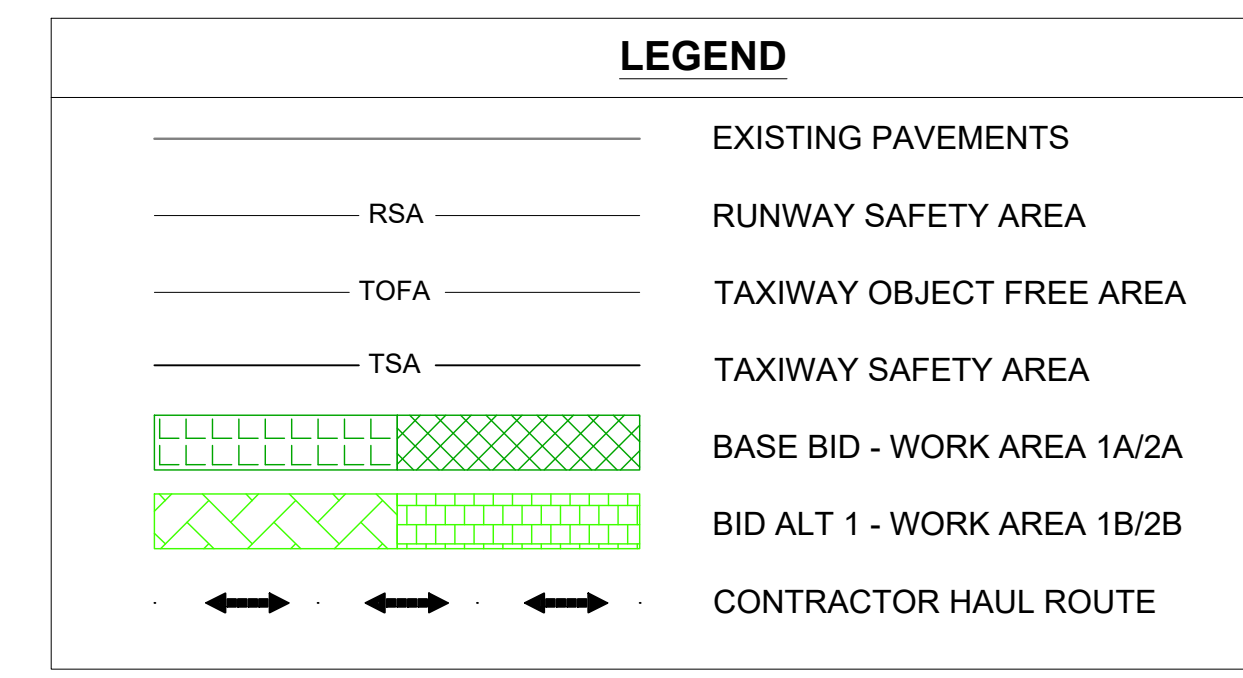

CRITICAL DIMENSIONS (TOTAL WIDTH):

RUNWAY 6-24:
 RDC: C-II-2400
 RSA: 500' WIDE
 OFZ: 400' WIDE
 OFA: 800' WIDE

RUNWAY 2-20:
 RDC: B-II-VISUAL
 RSA: 150' WIDE
 OFZ: 400' WIDE
 OFA: 500' WIDE

TAXIWAYS:
 TDG: 3 ADG: III
 TSA: 118' WIDE
 OFA: 171' WIDE

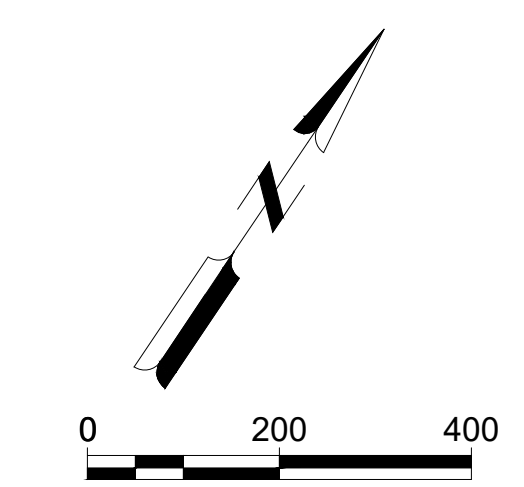

Mead & Hunt
 Mead and Hunt, Inc.
 3314 Market Street, Suite 301
 Camp Hill, PA 17011
 phone: 971-256-9307
 meadhunt.com

© Copyright 2025 Mead & Hunt, Inc.
 This document, or any portion thereof, shall not be duplicated, disclosed, or used on any other project or extension of this project except by written agreement with Mead & Hunt, Inc. Mead & Hunt shall not be responsible for any unauthorized use of, or alteration to these documents.

**ERIE INTERNATIONAL AIRPORT
 EXTEND TAXIWAY A, REALIGN TAXIWAYS D/G/F
 BID PACKAGE 1**

4411 W 12TH STREET
 ERIE, PA 16505

ISSUED
 5/1/2026 AS-BID

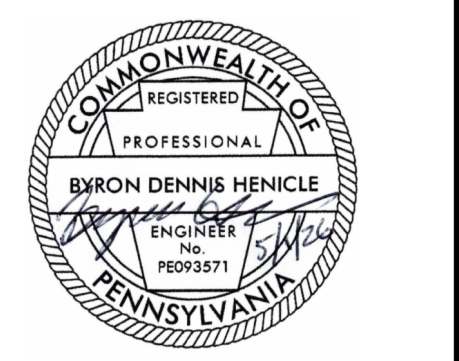

NOT FOR CONSTRUCTION

ASR NO: 3-42-0030-XXX-20XX
 MSH NO: 3225600-243123.01
 DATE: MAY 1, 2026
 DESIGNED BY: CJ
 DRAWN BY: SDB
 CHECKED BY: BDH
 DO NOT SCALE DRAWINGS

SHEET CONTENTS
 CONSTRUCTION
 SAFETY AND PHASING
 PLAN

SHEET NO. 10 OF 78

G-081

X:\3225600\243123.01\TECHNICAL\CONSTRUCTION SAFETY PHASING PLAN.DWG 4/30/2026 5:45:02 PM

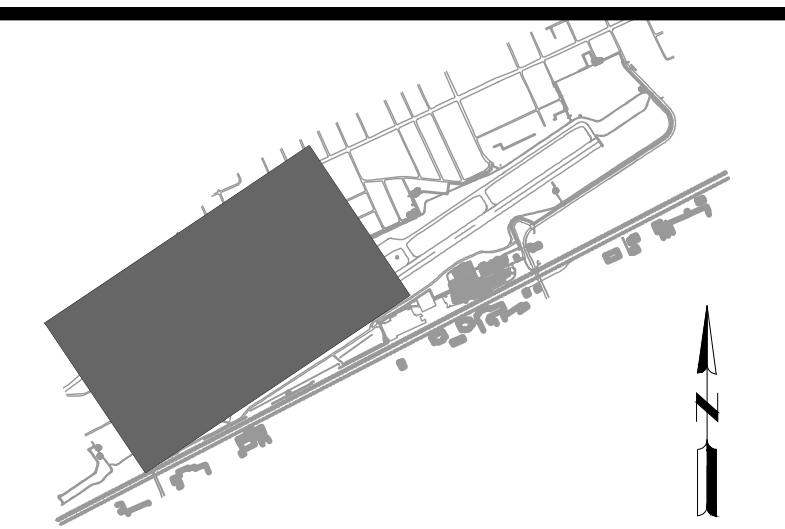

KEYMAP

© Copyright 2025 Mead & Hunt, Inc.
This document, or any portion thereof, shall not be duplicated, disclosed, or used on any other project or extension of this project except by written agreement with Mead & Hunt, Inc. Mead & Hunt shall not be responsible for any unauthorized use of, or alteration to these documents.

ERIE INTERNATIONAL AIRPORT EXTEND TAXIWAY A, REALIGN TAXIWAYS D/G/F BID PACKAGE 1

4411 W 12TH STREET
ERIE, PA 16505

ISSUED
5/1/2026 AS-BID



NOT FOR CONSTRUCTION

AIP NO: 3-42-0030-XXX-20XX
M&H NO: 3225600-243123.01
DATE: MAY 1, 2026
DESIGNED BY: CJ
DRAWN BY: SDB
CHECKED BY: BDH
DO NOT SCALE DRAWINGS

SHEET CONTENTS
CONSTRUCTION
SAFETY AND PHASING
PLAN - WORK AREA 1A

SHEET NO. 11 OF 78

G-082

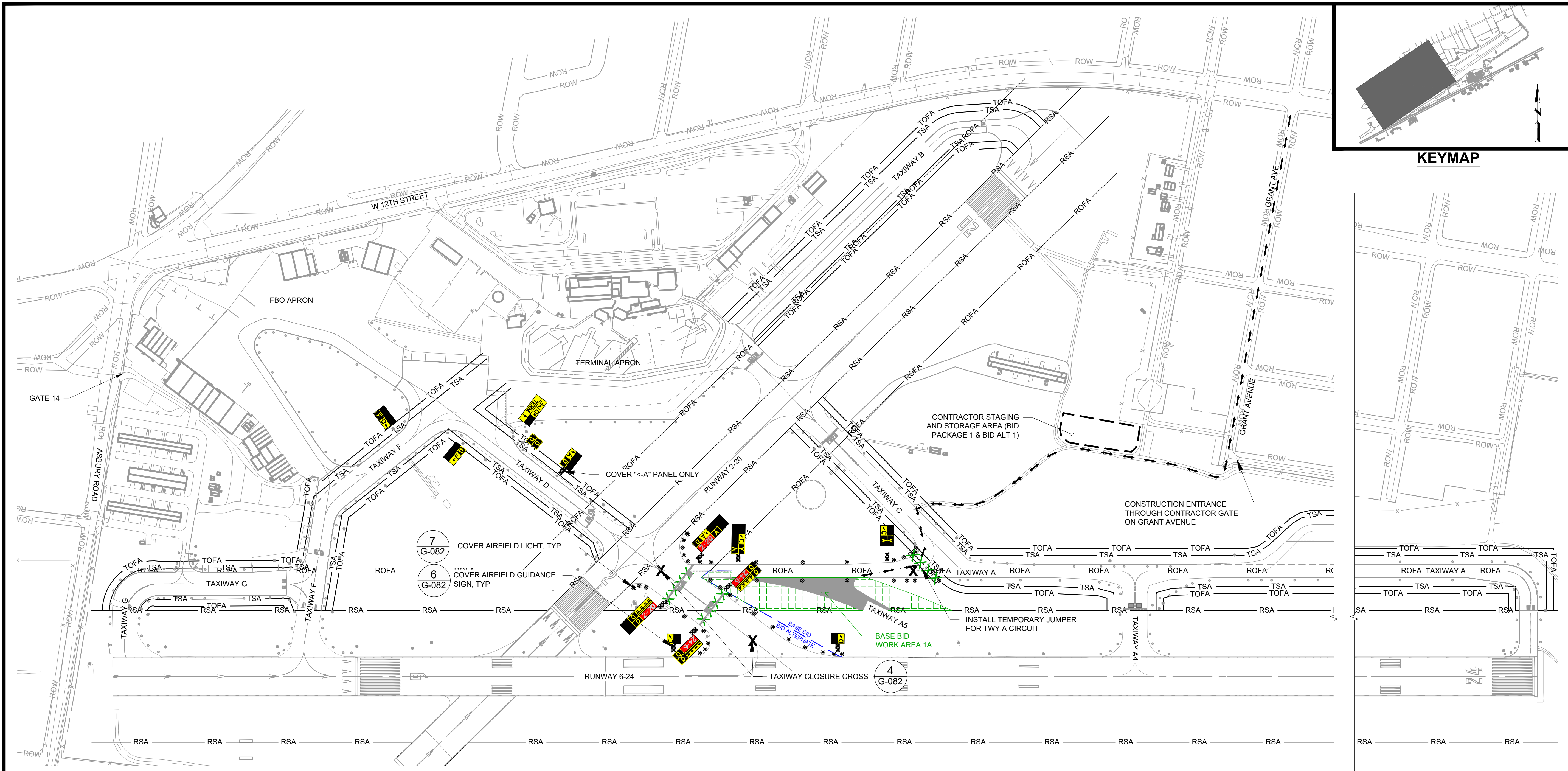

WORK AREA	CONSTRUCTION	AFFECTED ACTIVE OPERATION AREAS (AOA'S)	WORK HOURS	CONTRACT TIME	SAFETY AND SECURITY
1A	CONSTRUCT TAXIWAY A4 AS SHOWN. COMPLETE REMOVAL OF TAXIWAY A INCLUDING SAWCUTTING, PAVEMENT REMOVAL, BASE COURSE, PAVEMENT, TOPSOIL GRADING, SEEDING AND MULCHING. COMPLETE TAXIWAY EDGE LIGHTING AND GUIDANCE SIGN MODIFICATIONS, EDGE RESTORATION AFTER PAVING, AND PLACE HALF-RATE MARKING ON NEW PAVEMENTS.	<ol style="list-style-type: none"> TAXIWAY A CLOSED (TWY C TO RWY 2-20) <ol style="list-style-type: none"> FAA FLIGHT PROCEDURES MAY INCREASE VISIBILITY MINIMUMS ON RUNWAY 6-24 TAXIWAY D CLOSED(RWY 2-20 TO RWY 6-24). TAXIWAY C OPEN. <ol style="list-style-type: none"> CONTRACTOR SHALL PROVED VAC TRUCK TO PREFORM CLEANING AND VACUUMING OF TAXIWAY C DURING CONSTRUCTION HOURS TO PREVENT FOD WHEN AIRCRAFT USE TAXIWAY C 	NORMAL / UN-RESTRICTED	30 CALENDAR DAYS	<p>THE CONTRACTOR SHALL NOTIFY THE AIRPORT AT LEAST 5 DAYS IN ADVANCE OF WORK AND WORK AREA CHANGES SO THAT THE AIRPORT MANAGEMENT CAN ISSUE A NOTAM OF CONSTRUCTION ACTIVITY.</p> <ol style="list-style-type: none"> ALL GATES MUST BE LOCKED OR GATE GUARD POSTED. ALL CONTRACTOR PERSONNEL WORKING ON-SITE SHALL UNDERGO AIRPORT TRAINING AND HAVE AIRPORT ISSUED BADGE. MAXIMUM EQUIPMENT HEIGHT FOR THE PROPOSED WORK AREA IS 25' UNLESS OTHERWISE NOTED.

LEGEND

- EXISTING PAVEMENTS
- RUNWAY SAFETY AREA
- TAXIWAY OBJECT FREE AREA
- TAXIWAY SAFETY AREA
- BASE BID - WORK AREA 1A
- CONTRACTOR HAUL ROUTE

CRITICAL DIMENSIONS (TOTAL WIDTH):

RUNWAY 6-24:
RDC: C-II-2400
RSA: 500' WIDE
OFZ: 400' WIDE
OFA: 800' WIDE

RUNWAY 2-20:
RDC: B-II-VISUAL
RSA: 150' WIDE
OFZ: 400' WIDE
OFA: 500' WIDE

TAXIWAYS:
TDG: 3 ADG: III
TSA: 118' WIDE
OFA: 171' WIDE

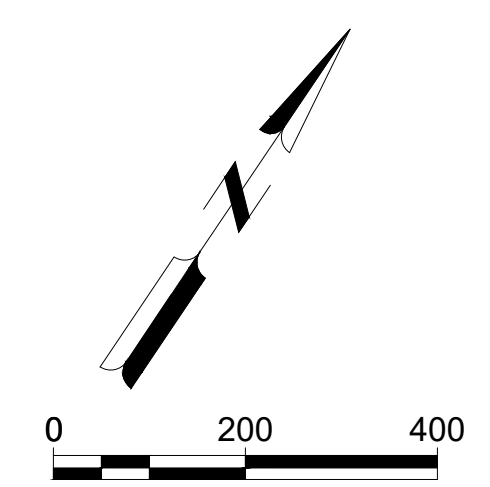

X:\3225600\243123.01\TECH\CAD\CONSTRUCTION SAFETY PHASING PLAN.DWG 4/30/2026 5:45:12 PM

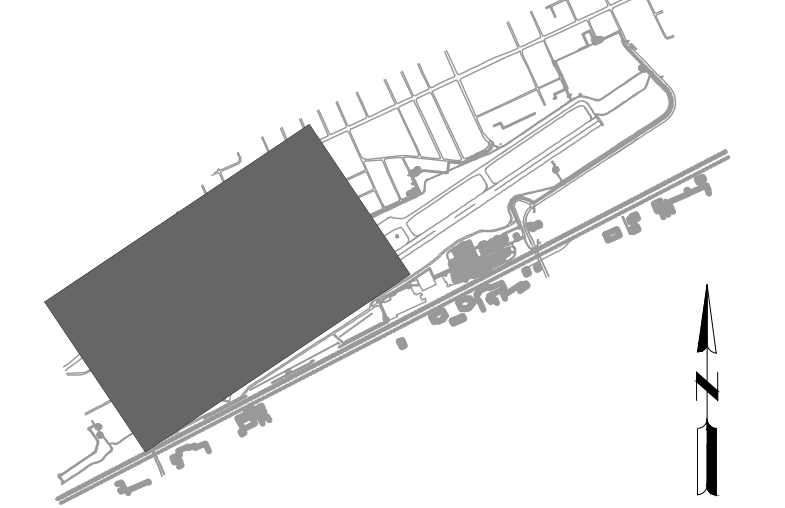

KEYMAP

© Copyright 2025 Mead & Hunt, Inc.
This document, or any portion thereof, shall not be duplicated, disclosed, or used on any other project or extension of this project except by written agreement with Mead & Hunt, Inc. Mead & Hunt shall not be responsible for any unauthorized use of, or alteration to these documents.

ERIE INTERNATIONAL AIRPORT EXTEND TAXIWAY A, REALIGN TAXIWAYS D/G/F BID PACKAGE 1 4411 W 12TH STREET ERIE, PA 16505

ISSUED
5/1/2026 AS-BID

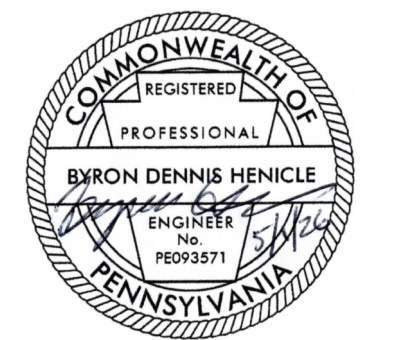

NOT FOR CONSTRUCTION

AIP NO: 3-42-0030-XXX-20XX
MSH NO: 3225600-243123.01
DATE: MAY 1, 2026
DESIGNED BY: CJ
DRAWN BY: SDB
CHECKED BY: BDH
DO NOT SCALE DRAWINGS

SHEET CONTENTS
CONSTRUCTION
SAFETY AND PHASING
PLAN - WORK AREA
2A

SHEET NO. 12 OF 78

G-083

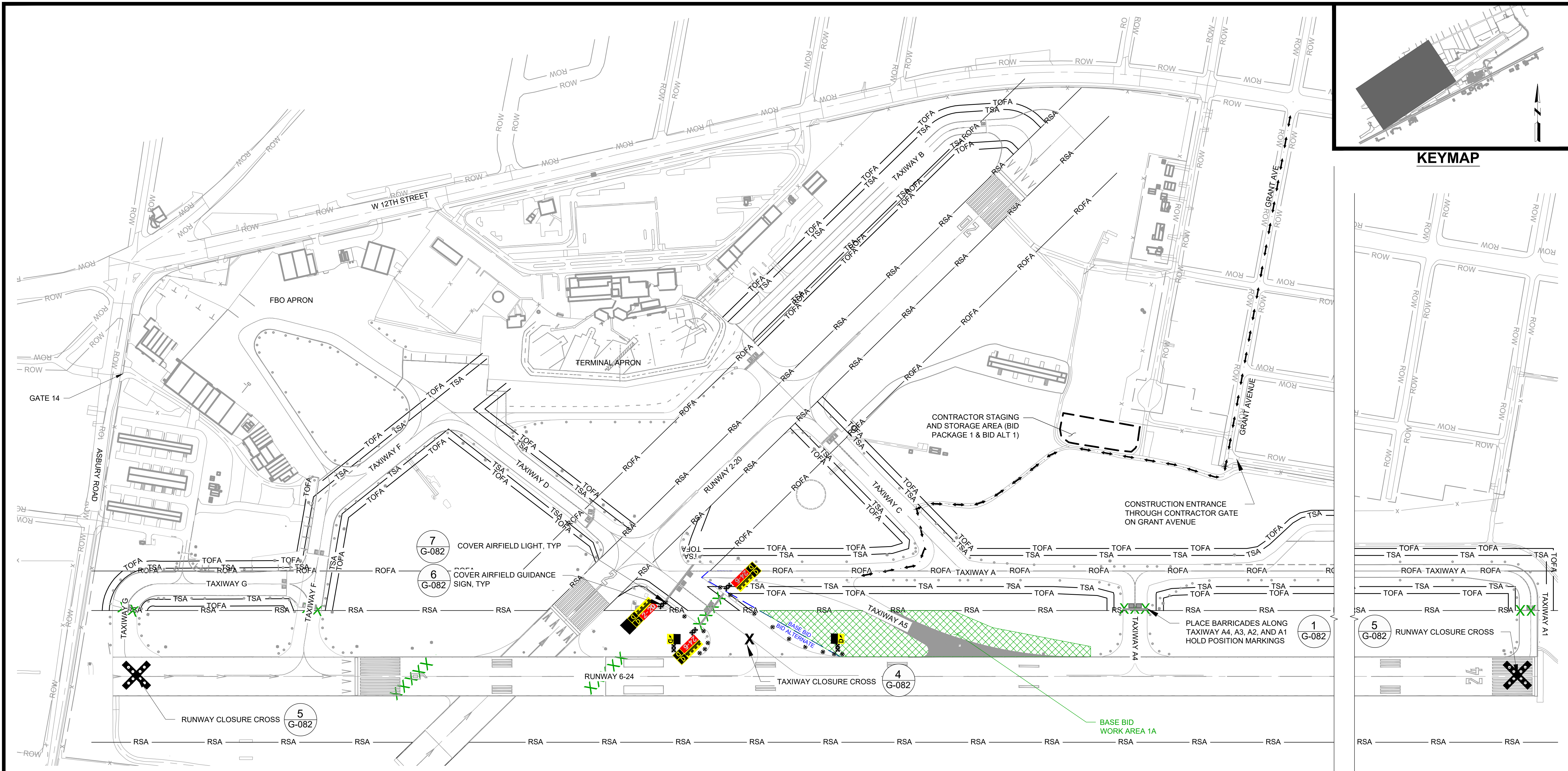

WORK AREA	CONSTRUCTION	AFFECTED ACTIVE OPERATION AREAS (AOA'S)	WORK HOURS	CONTRACT TIME	SAFETY AND SECURITY
2A	ALL WORK WITHIN THE 500' WIDE RSA. CONSTRUCT TAXIWAY A5 AS SHOWN.	1. RUNWAY 6-24 CLOSED	SEE GENERAL NOTE 8	30 CALENDAR DAYS	

LEGEND

- EXISTING PAVEMENTS
- RUNWAY SAFETY AREA
- TAXIWAY OBJECT FREE AREA
- TAXIWAY SAFETY AREA
- BASE BID - WORK AREA 2A
- CONTRACTOR HAUL ROUTE

CRITICAL DIMENSIONS (TOTAL WIDTH):

RUNWAY 6-24:
RDC: C-II-2400
RSA: 500' WIDE
OFZ: 400' WIDE
OFA: 800' WIDE

RUNWAY 2-20:
RDC: B-II-VISUAL
RSA: 150' WIDE
OFZ: 400' WIDE
OFA: 500' WIDE

TAXIWAYS:
TDG: 3 ADG: III
TSA: 118' WIDE
OFA: 171' WIDE

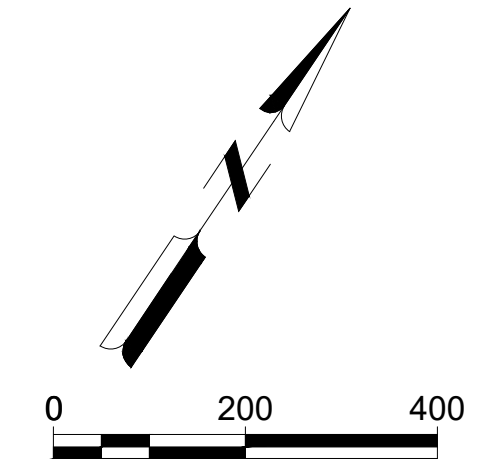

X:\3225600\243123.01\TECHNICAL\CONSTRUCTION SAFETY PHASING PLAN.DWG 4/30/2026 5:45:22 PM



KEYMAP

© Copyright 2025 Mead & Hunt, Inc.
This document, or any portion thereof, shall not be duplicated, disclosed, or used on any other project or extension of this project except by written agreement with Mead & Hunt, Inc. Mead & Hunt shall not be responsible for any unauthorized use of, or alteration to these documents.

ERIE INTERNATIONAL AIRPORT EXTEND TAXIWAY A, REALIGN TAXIWAYS D/G/F BID PACKAGE 1 4411 W 12TH STREET ERIE, PA 16505

ISSUED
5/1/2026 AS-BID

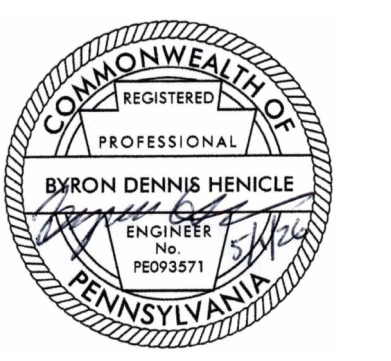

NOT FOR CONSTRUCTION

AIP NO: 3-42-0030-XXX-20XX
M&H NO: 3225600-243123.01
DATE: MAY 1, 2026
DESIGNED BY: CJ
DRAWN BY: SDB
CHECKED BY: BDH
DO NOT SCALE DRAWINGS

SHEET CONTENTS
CONSTRUCTION
SAFETY AND PHASING
PLAN - WORK AREA 1B

SHEET NO. 13 OF 78

G-084

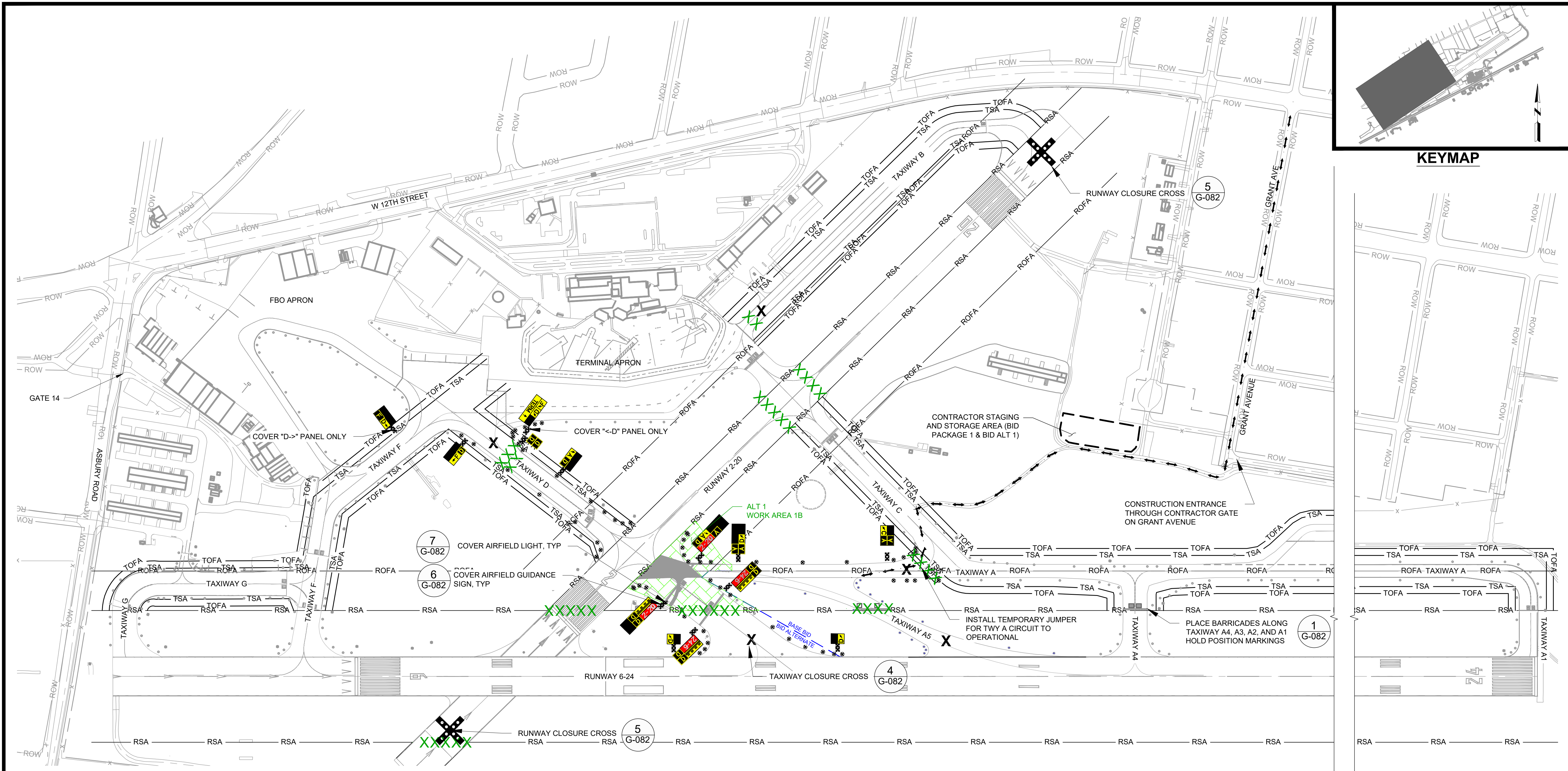

WORK AREA	CONSTRUCTION	AFFECTED ACTIVE OPERATION AREAS (AOA'S)	WORK HOURS	CONTRACT TIME	SAFETY AND SECURITY
1B	CONSTRUCT TAXIWAY A WITHIN RUNWAY 2-20 ROFA.	<ol style="list-style-type: none"> RUNWAY 2-20 CLOSED. TAXIWAY A CLOSED (TWY C TO RWY 2-20). TAXIWAY D CLOSED. TAXIWAY B CLOSED. TAXIWAY A5 CLOSED. 	SEE GENERAL NOTE 8	15 CALENDAR DAYS	

LEGEND

- EXISTING PAVEMENTS
- RSA - RUNWAY SAFETY AREA
- TOFA - TAXIWAY OBJECT FREE AREA
- TSA - TAXIWAY SAFETY AREA
- ALT 1 - WORK AREA 1B
- CONTRACTOR HAUL ROUTE

CRITICAL DIMENSIONS (TOTAL WIDTH):

RUNWAY 6-24:
RDC: C-II-2400
RSA: 500' WIDE
OFZ: 400' WIDE
OFA: 800' WIDE

RUNWAY 2-20:
RDC: B-II-VISUAL
RSA: 150' WIDE
OFZ: 400' WIDE
OFA: 500' WIDE

TAXIWAYS:
TDG: 3 ADG: III
TSA: 118' WIDE
OFA: 171' WIDE

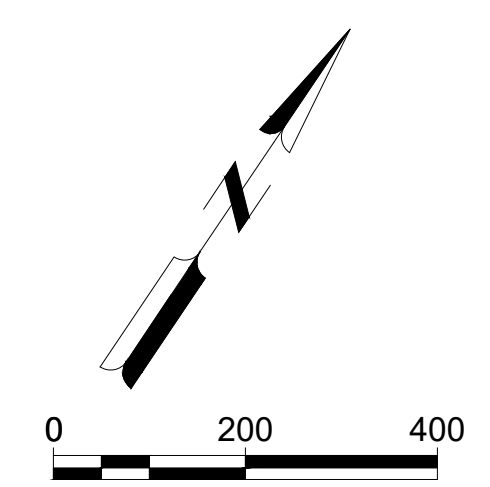

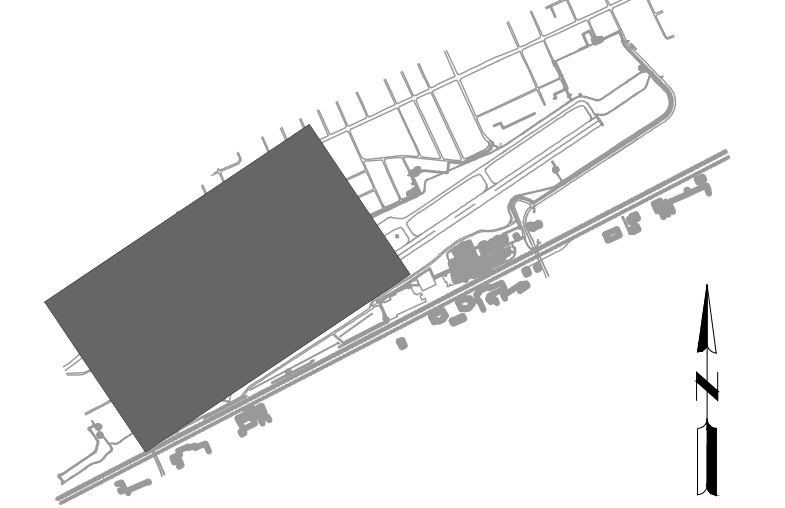

KEYMAP

© Copyright 2025 Mead & Hunt, Inc.
This document, or any portion thereof, shall not be duplicated, disclosed, or used on any other project or extension of this project except by written agreement with Mead & Hunt, Inc. Mead & Hunt shall not be responsible for any unauthorized use of, or alteration to these documents.

ERIE INTERNATIONAL AIRPORT EXTEND TAXIWAY A, REALIGN TAXIWAYS D/G/F BID PACKAGE 1 4411 W 12TH STREET ERIE, PA 16505

ISSUED
5/1/2026 AS-BID

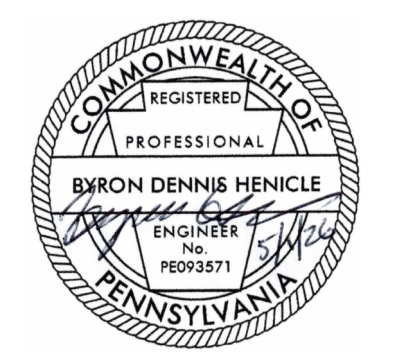

NOT FOR CONSTRUCTION

AIP NO: 3-42-0030-XXX-20XX
M&H NO: 3225600-243123.01
DATE: MAY 1, 2026
DESIGNED BY: CJ
DRAWN BY: SDB
CHECKED BY: BDH
DO NOT SCALE DRAWINGS

SHEET CONTENTS
CONSTRUCTION
SAFETY AND PHASING
PLAN - WORK AREA 2B

SHEET NO. 14 OF 78

G-085

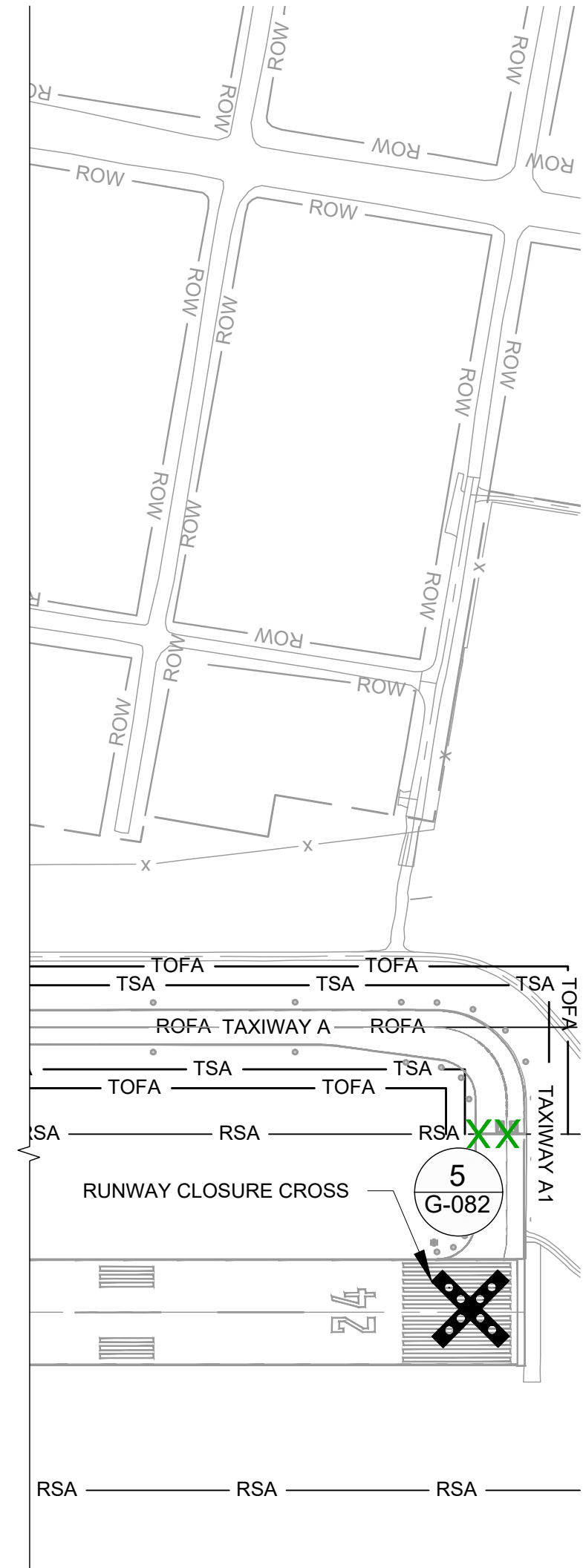
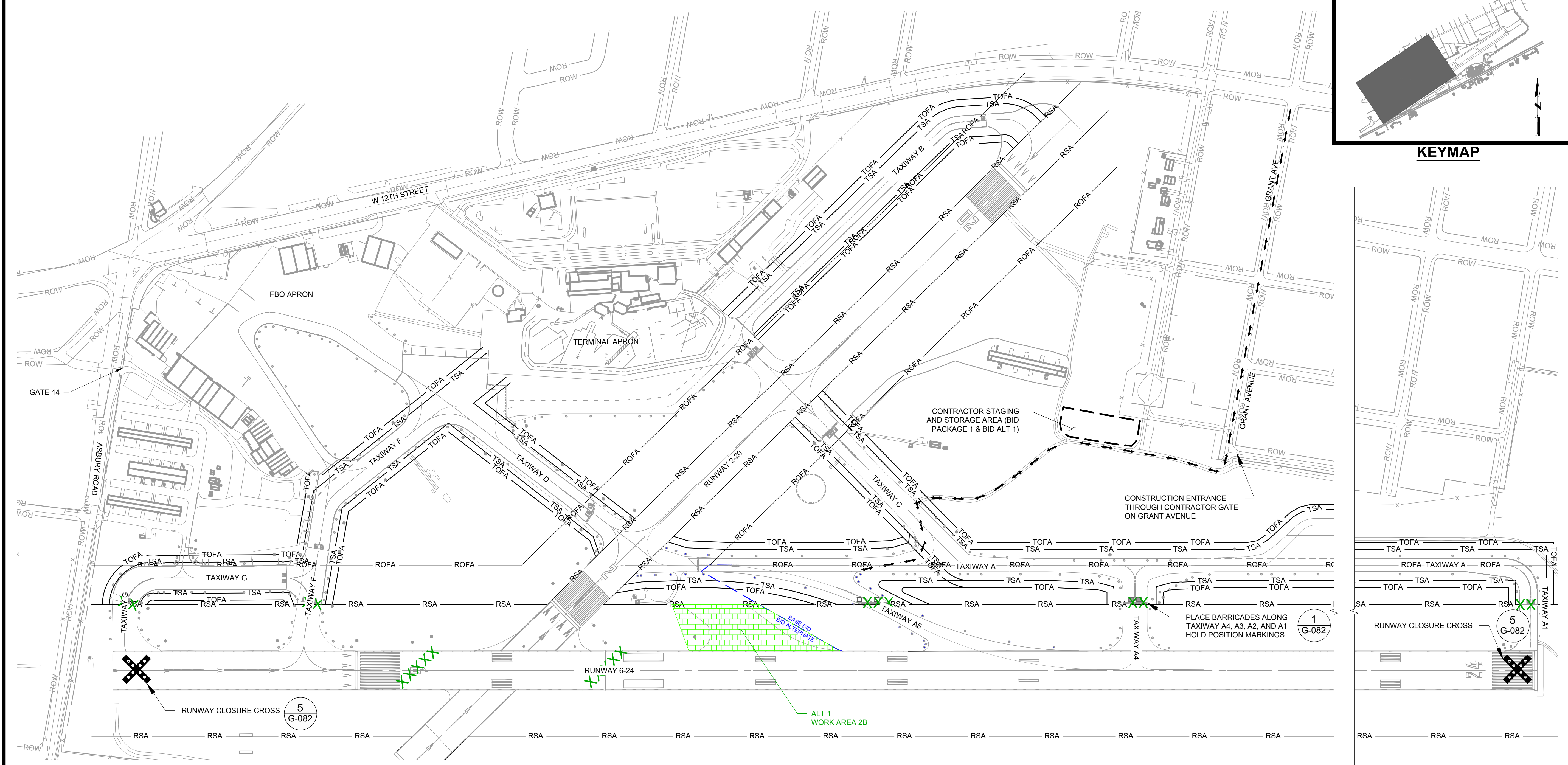

WORK AREA	CONSTRUCTION	AFFECTED ACTIVE OPERATION AREAS (AOA'S)	WORK HOURS	CONTRACT TIME	SAFETY AND SECURITY
2B	ALL WORK WITHIN THE 500' WIDE RSA. DEMO EXISTING TAXIWAY D.	1. RUNWAY 6-24 CLOSED	SEE GENERAL NOTE 8	15 CALENDAR DAYS	

LEGEND

- EXISTING PAVEMENTS
- RUNWAY SAFETY AREA
- TAXIWAY OBJECT FREE AREA
- TAXIWAY SAFETY AREA
- ALT 1 - WORK AREA 2B
- CONTRACTOR HAUL ROUTE

CRITICAL DIMENSIONS (TOTAL WIDTH):

RUNWAY 6-24:
RDC: C-II-2400
RSA: 500' WIDE
OFZ: 400' WIDE
OFA: 800' WIDE

RUNWAY 2-20:
RDC: B-II-VISUAL
RSA: 150' WIDE
OFZ: 400' WIDE
OFA: 500' WIDE

TAXIWAYS:
TDG: 3 ADG: III
TSA: 118' WIDE
OFA: 171' WIDE

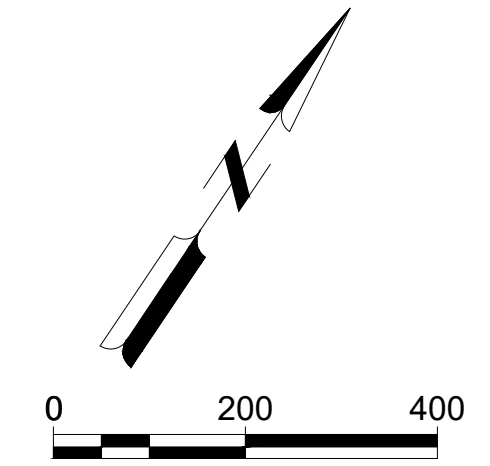

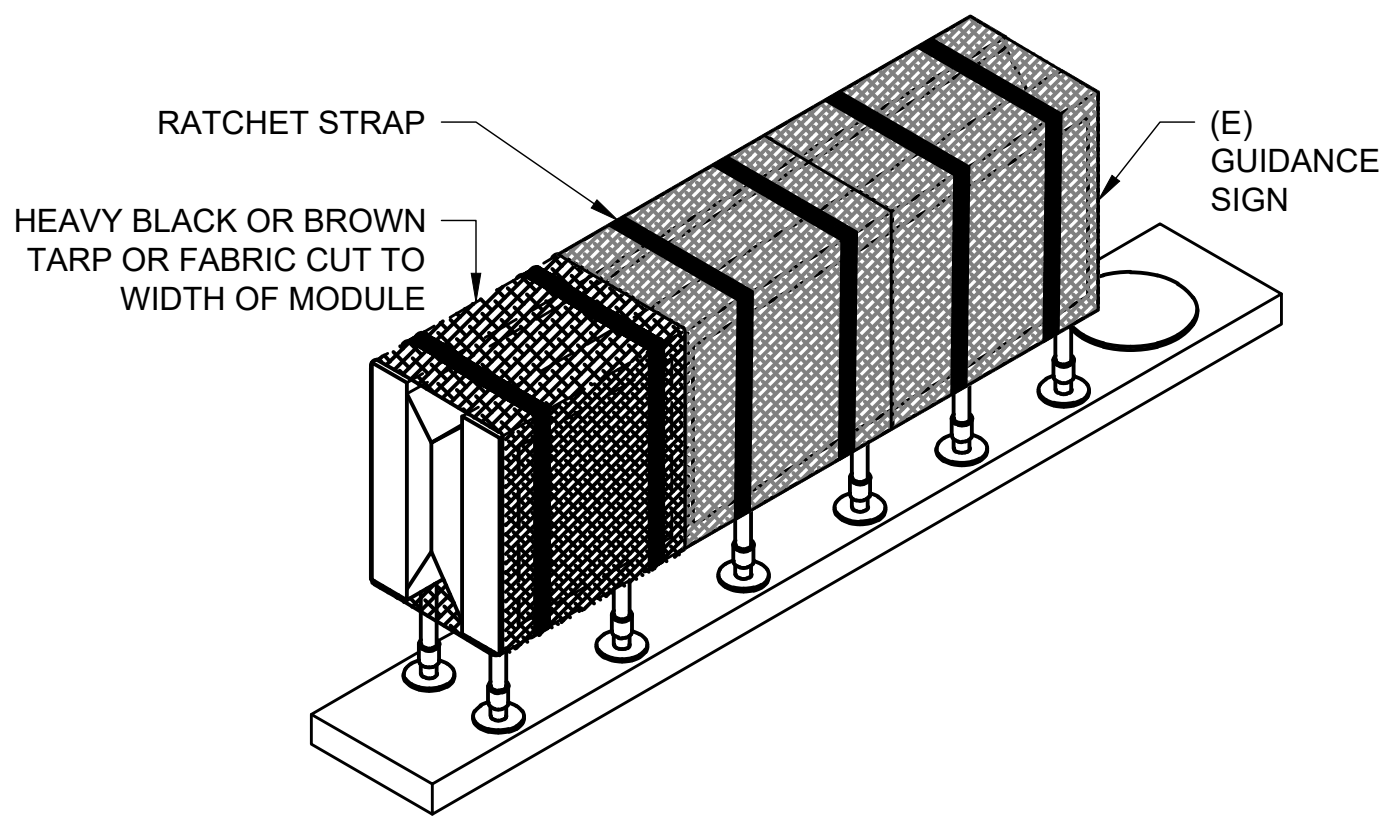

NOTES:

1. CONTRACTOR SHALL NOT USE TAPE TO SECURE COVER TO SIGN.
2. MINIMUM TWO (2) STRAPS TO BE USED TO COVER EACH SIGN MODULE.
3. STRAPS AND COVER TO BE APPROVED BY AIRPORT OPERATIONS.
4. CONTRACTOR SHALL MAINTAIN ITEMS USED TO COVER/OBSCURE AIRFIELD SIGN THROUGHOUT DURATION OF THE PHASE.
5. MATERIAL USED TO COVER SIGN SHALL OBSCURE LIGHT FROM SIGN AT NIGHT.

6 GUIDANCE SIGN COVER
NOT TO SCALE

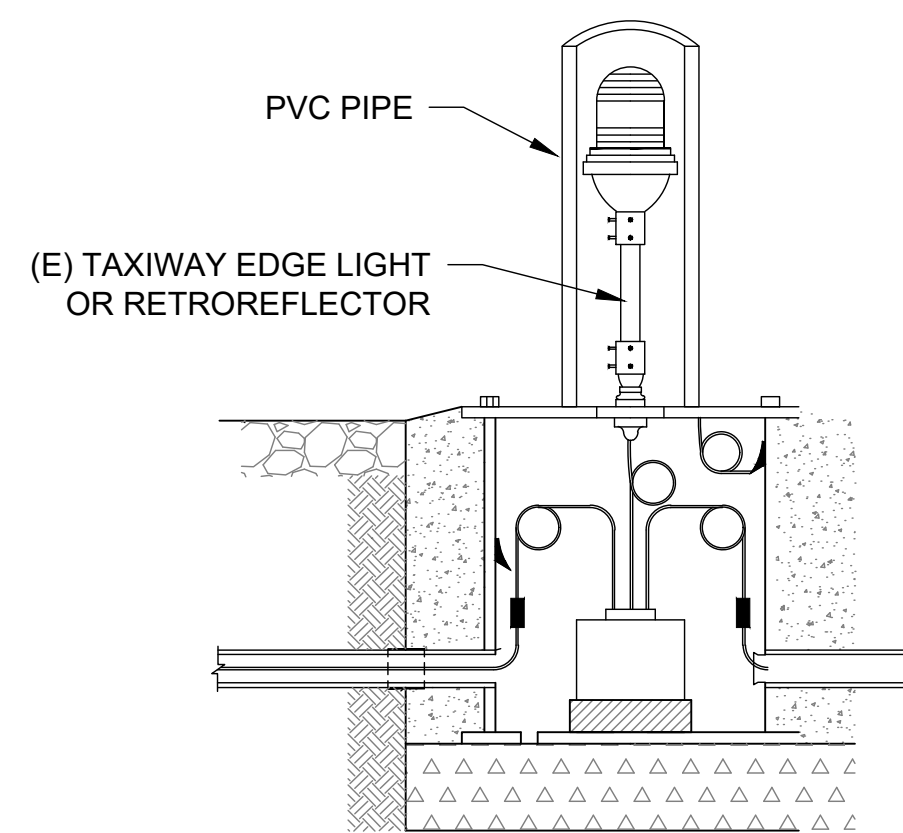

NOTES:

1. PVC PIPE OR APPROVED ALTERNATIVE USED TO COVER EACH LIGHT SHALL BE A SUFFICIENT LENGTH TO COMPLETELY OBSCURE THE LIGHT. EXISTING TAXIWAY EDGE LIGHT HEIGHT IS APPROXIMATELY 14".
2. CONTRACTOR SHALL MAINTAIN ITEMS USED TO COVER/OBSCURE AIRFIELD LIGHT THROUGHOUT DURATION OF THE PHASE.
3. CONTRACTOR SHALL CONFIRM THE NUMBER OF LIGHT COVERS REQUIRED TO COMPLETE THE PROJECT BASED ON THE PHASING REQUIREMENTS SHOWN ON THIS PLAN.
4. CONTRACTOR SHALL CONFIRM ACCEPTABLE METHOD OF OBSCURING LIGHTS WITH AIRPORT OPERATIONS AT THE PRE-CONSTRUCTION MEETING.

7 AIRFIELD LIGHT COVER
NOT TO SCALE

Figure A-27. Closed Runway and Taxiway Markings

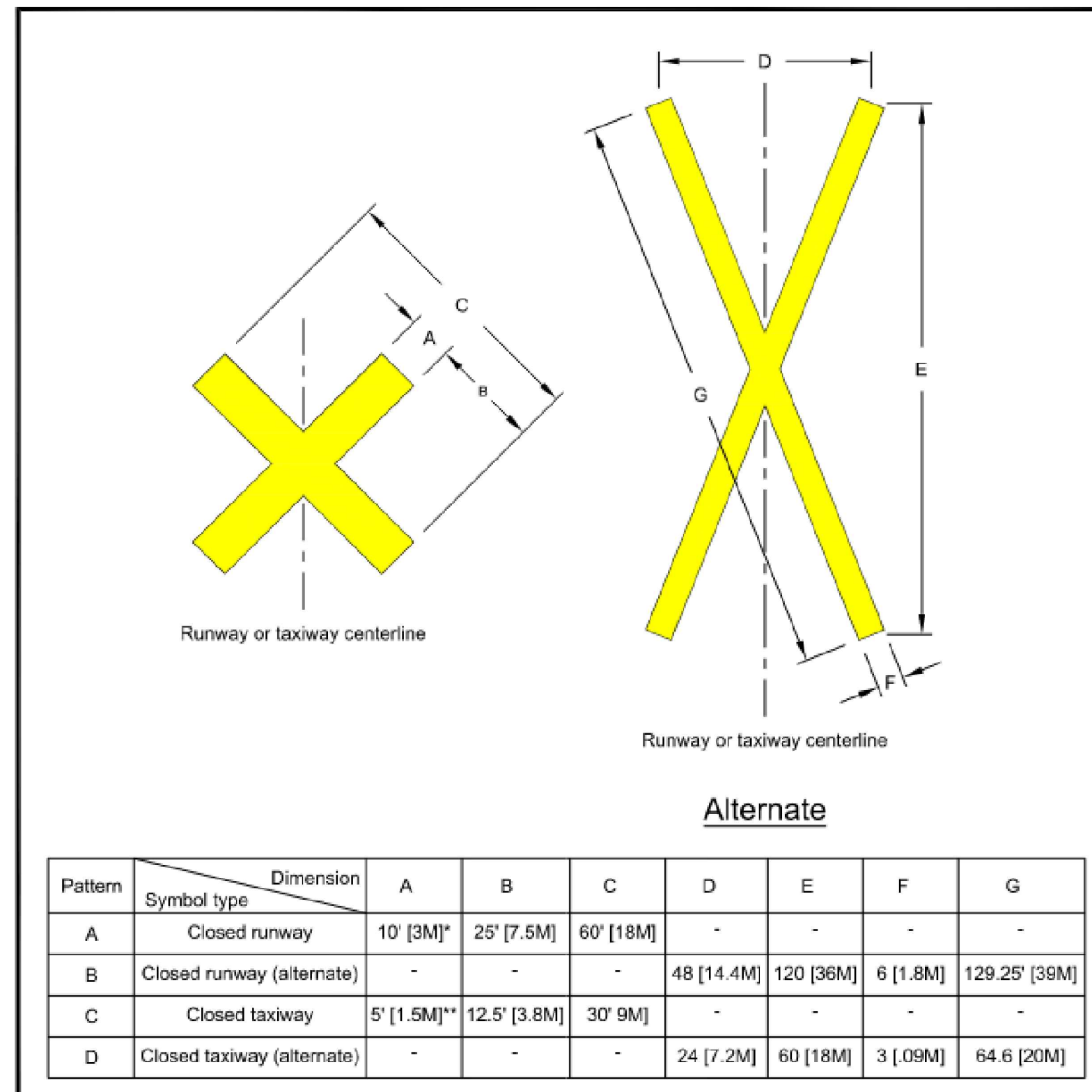

Note: Both symbols are always painted yellow.

* For temporary symbol, this dimension may be changed to 8 ft (2.4m).

** For temporary symbol, this dimension may be changed to 4 ft (1.2m).

4 CLOSED RUNWAY AND TAXIWAY MARKINGS
NOT TO SCALE

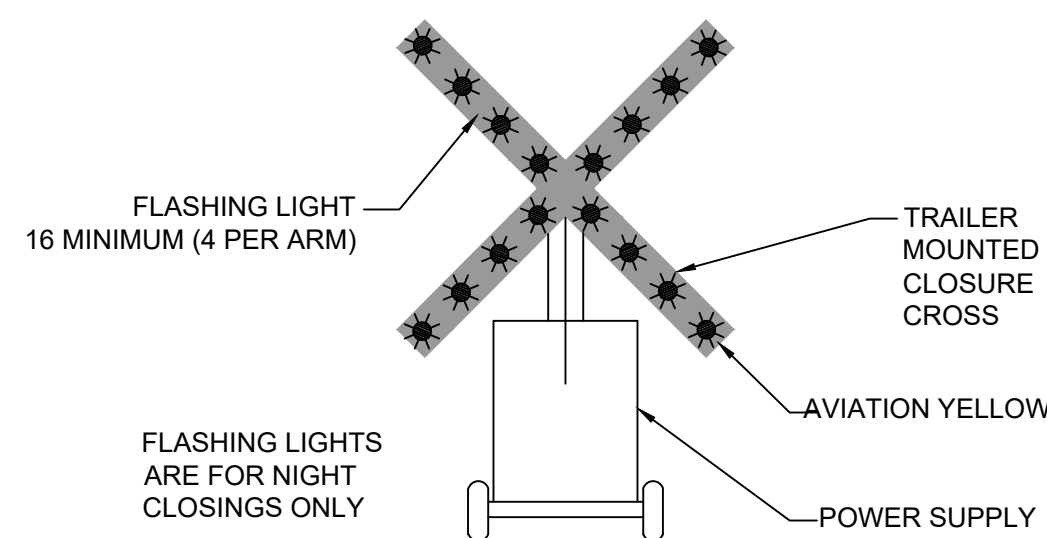

TEMPORARY CLOSURE CROSS DETAIL

NOTE:

1. THE OWNER SHALL SUPPLY. THE CONTRACTOR SHALL MAINTAIN TWO GENERATOR-POWERED, LIGHTED CLOSURE MARKERS FOR THE DURATION REQUIRED. MARKERS SHALL BE MOVED, FUELED, OILED AND MAINTAINED BY THE CONTRACTOR FOR THE DURATION REQUIRED.
2. MARKERS SHALL BE PLACED ON RUNWAY NUMERALS FOR THE ENTIRE PERIOD OF TIME THAT RUNWAY 6-24 OR RUNWAY 2-20 IS CLOSED AS SHOWN.
3. CLOSURE MARKERS SHALL BE CERTIFIED AND CURRENTLY APPROVED EQUIPMENT PER THE CURRENT EDITIONS OF FAA AC 150/5345-53 AND FAA AC 150/5345-55.

5 PORTABLE LIGHTED RUNWAY CLOSURE MARKERS
NOT TO SCALE

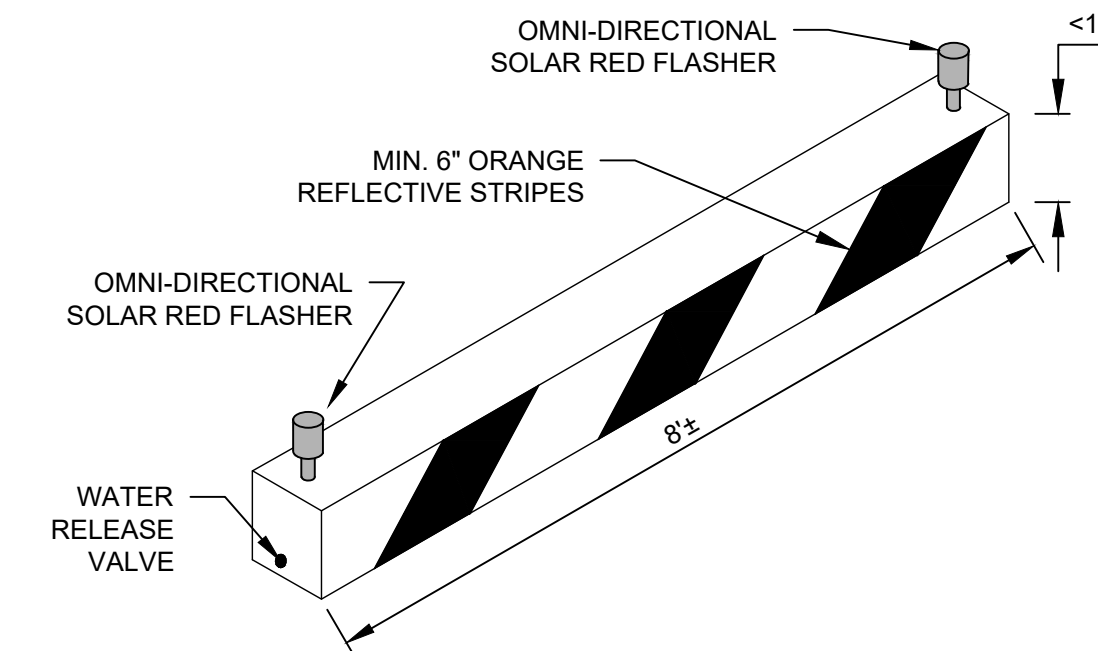

NOTES:

1. CONTRACTOR SHALL SUPPLY AND MAINTAIN LOW-LEVEL LIGHTED BARRICADES FOR THE DURATION OF THE PROJECT.
2. GAPS IN BARRICADES SHALL NOT EXCEED 5-FEET.
3. THERE SHALL BE NO GAPS IN BARRICADES PLACED AT RUNWAYS.

1 LOW-LEVEL LIGHTED BARRICADE DETAIL
NOT TO SCALE

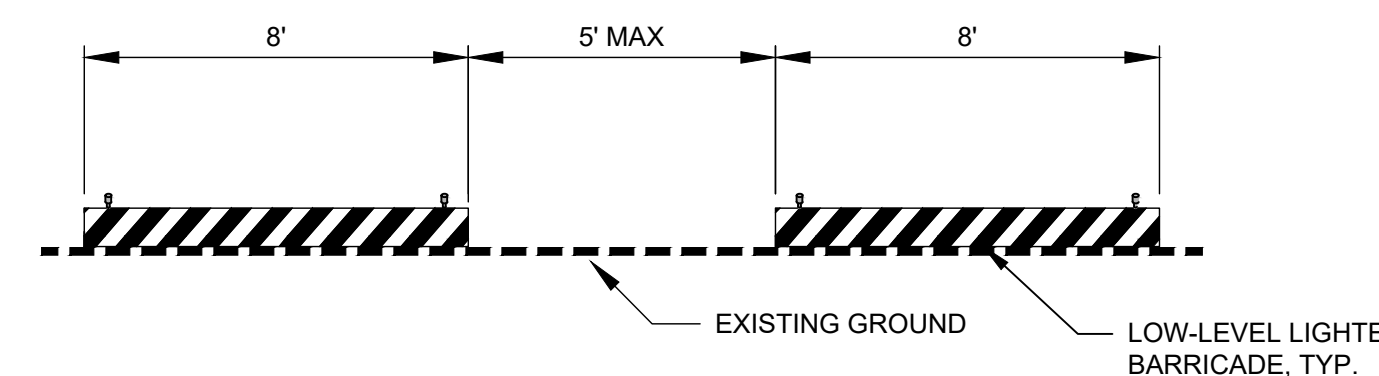

2 LOW-LEVEL LIGHTED BARRICADE LAYOUT DETAIL
NOT TO SCALE

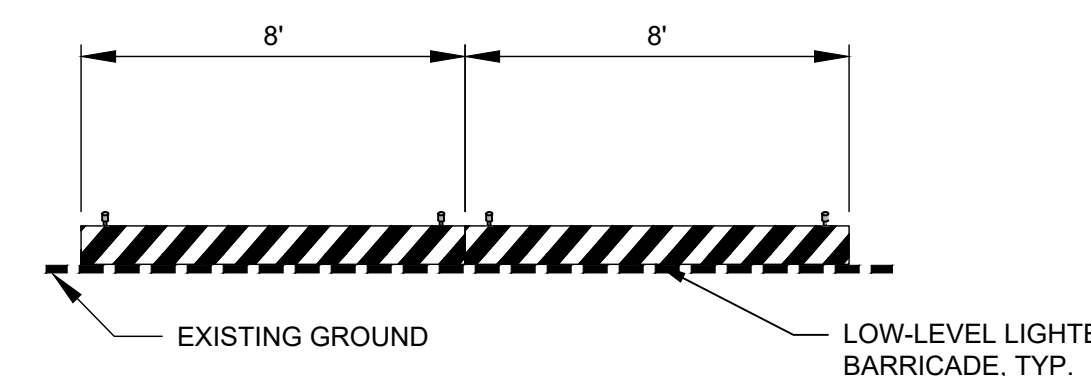

3 LOW-LEVEL LIGHTED BARRICADE PLACED AT RUNWAYS DETAIL
NOT TO SCALE

© Copyright 2025 Mead & Hunt, Inc. This document, or any portion thereof, shall not be duplicated, disclosed, or used on any other project or extension of this project except by written agreement with Mead & Hunt, Inc. Mead & Hunt shall not be responsible for any unauthorized use of, or alteration to these documents.

ERIE INTERNATIONAL AIRPORT
EXTEND TAXIWAY A, REALIGN TAXIWAYS D/G/F
BID PACKAGE 1
4411 W 12TH STREET
ERIE, PA 16505

ISSUED
5/1/2026 AS-BID



NOT FOR CONSTRUCTION

AIP NO: 3-42-0030-XXX-20XX
MSH NO: 3225600-243123.01
DATE: MAY 1, 2026
DESIGNED BY: CJ
DRAWN BY: SDB
CHECKED BY: BDH
DO NOT SCALE DRAWINGS

SHEET CONTENTS
CONSTRUCTION
SAFETY AND PHASING
DETAILS

SHEET NO. 15 OF 78

G-086